



KAVANDISH SYSTEM

# USER MANUAL



**All in one: ESU +  
Sealing System +  
Argon Cut & Coagulation**

** iconic Family**

**User Manual**

# **Iconic**

## **Electrosurgical Generators**

V2.2  
June 2023

## Preface

This User Manual and the device which is described have been only prepared for qualified medical professionals who have been trained for the particular technique and surgical procedure to be performed. This manual is designed only for using Iconic family devices, a product of Kavandish System Company. More technical information for authorized service personnel of this company and its authorized representatives is available in the Service Manual.

**This manual covers following devices:**

**Software Ver. 3.0.0 and higher for Iconic IS410 and Iconic IS410S**

Made in IRAN

Printed in IRAN



Kavandish System Co.

Pardis technology park, Damavand Rd. 20<sup>th</sup> Km. Tehran, Iran.

Factory: Tel: (+98-21) 76250635-38 Fax: (+98-21) 76250639

Sales Office: Tel: (+98-21) 88531318-19 Fax: (+98-21) 88519063

E-mail: info@kavandish.ir

[www.kavandish.ir](http://www.kavandish.ir)



Trionara Technologies AB.

Polygonvägen 21, 18766, Täby, Sweden.

Phone Number : +46 31 135514

Email: info@trionara.com



## Intended Use

Iconic family devices are electrosurgical generators used for cutting and coagulation of biological tissue in general and specialized surgery. The devices use HF (>100Khz) electrical current thermal effects for obtaining cutting and coagulation. Intended patient population can be of any age, weight or gender.

## Conventions Used in this Manual

### WARNING

Indicates a potentially hazardous situation which, if it is not avoided, it could result in death or serious injury.

### CAUTION

Indicates a potentially hazardous situation which, if it is not avoided, it may result in medium or minor injury.

### NOTICE

Indicates an operating tip, maintenance suggestion or a hazard which may damage the device.

## Warranty

- This product is warranted for 24 months from the date of device delivery to the user. During this period any failure in the device due to defective parts or system error caused by manufacture will be fixed free of charge in the company.
- To receive the warranty card, please complete the yellow sheet related to warranty card request and post it to company at the earliest time (before sending it, note that it has been filled correctly and completely).
- Failure due to negligence in transportation or incorrect use of the product will not be covered by the warranty.
- During the warranty period, any repair must be carried out by Kavandish System Company or its authorized representatives; otherwise the warranty will be canceled.
- Accessories are not covered by the warranty and in case of damage must be replaced.

## Guarantee

- Kavandish System Company agrees to repair and provide the spare parts for 10 years from the delivery date of the product.

# Table of Contents

<b>Chapter 1: Overview and General Features .....</b>	<b>1</b>
Introduction .....	2
Front Panel Features .....	3
Back Panel Features .....	4
Signs Used on Front and Back Panels .....	5
<b>Chapter 2: General Warnings and Safety Notices .....</b>	<b>7</b>
Launching and Using the Device .....	8
Fire Hazard .....	10
Electromagnetic Interference .....	11
Accessories .....	11
Footswitch .....	12
Monopolar .....	13
Plate .....	13
Bipolar .....	15
Sealing (Iconic IS410S Models) .....	15
After surgery .....	16
Repairing or Servicing .....	17
<b>Chapter 3: Installation and Launching .....</b>	<b>18</b>
Before Launching .....	19
Turning on the Device .....	19
Checking the Device before Using in Operating Room .....	20
<b>Chapter 4: Monopolar Technique .....</b>	<b>21</b>
Information Regarding Monopolar in Receptacles Module Section .....	22
Monopolar Receptacles and their Accessories .....	22
Monopolar Instruments .....	23
Monopolar Electrodes .....	24
Patient Plate .....	25
Plate Indicators on the Panel .....	25
Patient Plate Monitoring System .....	25
Material and Dimension Selection of Patient Plate .....	27
Footswitch .....	27
Capability of Using Argon Gas .....	28
Information Regarding Monopolar Cut in Mode and Power Setting Section .....	29
Monopolar Cut Modes .....	30
Information Regarding Monopolar Coag. in Mode and Power Setting Section .....	31
Monopolar Coag. Modes .....	32
Power Level Changes in Monopolar .....	32

Output Power Selection in Monopolar .....	33
Method of Monopolar Cut Setting .....	33
Method of Monopolar Coag. Setting.....	33
Method of Using Monopolar .....	33
<b>Chapter 5: Bipolar Technique.....</b>	<b>34</b>
Information Regarding Bipolar in Receptacles Module Section .....	35
Bipolar Receptacle and its Accessories .....	35
Bipolar Instruments.....	36
Bipolar Coag. Forceps.....	36
Bipolar Cut Scissors.....	37
Information Regarding Bipolar in Mode and Power Setting Section .....	38
Bipolar Modes .....	39
Power Level Changes in Bipolar .....	39
Output Power Selection in Bipolar .....	39
Method of Bipolar Setting.....	39
Method of Using Bipolar.....	40
Footswitch.....	40
<b>Chapter 6: Sealing Technique (Iconic IS410S Models).....</b>	<b>42</b>
Sealing Technique Features.....	43
Sealing Technique Advantages.....	43
Information Regarding Sealing in Receptacles Module Section.....	44
Sealing Receptacle and its Accessories .....	44
Sealing Instruments.....	45
Footswitch.....	47
Information Regarding Sealing in Mode and Power Setting Section .....	49
Sealing Modes .....	50
Output Power Selection in Sealing .....	50
Regrasp .....	50
Method of Sealing Setting.....	51
Method of Using Sealing.....	51
<b>Chapter 7: LCD Display Pages and How to Use them .....</b>	<b>53</b>
LCD Display Applications .....	54
Settings Pages.....	55
How to Enter the Setting Pages .....	55
How to Select Micro Surgery, General Surgery, TUR and Argon Endo Modes .....	55
How to Set Delay Time in Auto Start of Bipolar Coag. Mode .....	56
Programming Pages .....	57
How to Enter Programming Pages.....	58
How to Recall the Preset Program in the Memory.....	58
How to Save a Program.....	58

Display Page of Alarm Codes which are Generated while Working with the Device.....	59
How to Observe the Logged Alarm Codes .....	59
<b>Chapter 8: Alarm System .....</b>	<b>60</b>
Alarm Conditions.....	61
Failure in Patient Plate Condition Alarm.....	62
System Memory Failure Alarm .....	62
Alarm Conditions Group .....	62
Alarm Conditions Priority .....	63
Alarm Signals .....	63
Alarm Signals Characteristics with Medium Priority.....	63
Alarm Signals Characteristics with Low Priority.....	63
Regrasp Alarm Signals Characteristics (Iconic IS410S Models).....	64
Alarm Signals Generation Ranking.....	64
Alarm Logging System in the Memory .....	64
Information Conditions .....	66
Information Signals Characteristics .....	66
Information Signals Rank in Comparison with Alarm Signals.....	66
<b>Chapter 9: Maintenance and Repair.....</b>	<b>68</b>
Manufacture Responsibility.....	69
Routine Maintenance .....	69
Safety Checks .....	69
Cleaning and Disinfecting .....	69
Cleaning Accessories .....	70
After Sales Service.....	70
<b>Chapter 10: Technical Specifications.....</b>	<b>71</b>
Dimensions and Weight .....	72
Input Power .....	72
Operating Parameters.....	72
Transport and Storage Parameters .....	72
Internal Memory .....	72
Displays.....	72
Generator Activation Tone .....	72
Current Consumption .....	73
High Frequency Leakage Current .....	73
Low Frequency Leakage Current.....	73
Patient Plate Monitoring System .....	73
Duty Cycle .....	73
Output Characteristics* .....	74
Standards.....	74
Drip Proof (IEC 60601-2-2).....	74

IEC Classification.....	75
Maximum Output Power Graphs versus Load Resistance.....	75
Output Power Graphs versus Adjusted Power Level .....	78
Maximum Output Voltage Graphs versus Adjusted Power Level .....	81
<b>Chapter 11: EMC Compliance .....</b>	<b>84</b>





# Chapter 1

## Overview and General Features

- Introduction
- Front Panel Features
- Back Panel Features
- Signs Used on Front and Back Panels

## **Introduction**

Iconic family electrosurgical generator are modern phenomena, perfect and applicable in all general and specialized surgery rooms, and enjoy the state of the art technology using the latest techniques in electrical and electronic design while complies with the latest international safety codes and standards and providing broad capabilities in electrosurgery.

Iconic IS410 electrosurgical generators are designed to provide Monopolar Cut, Monopolar Coagulation (Coag.), Bipolar Cut and Bipolar Coag. techniques for electrosurgery. Iconic IS410 generators are also equipped with Argon Cut and Argon Coagulation modes. (See capability of using argon gas on page 28 and User Manual of APS1 argon supplier device).

Iconic IS410S electrosurgical generators besides covering all techniques in Iconic IS410 product, provide Sealing technique as well (see chapter 6, Sealing technique).



## Front Panel Features

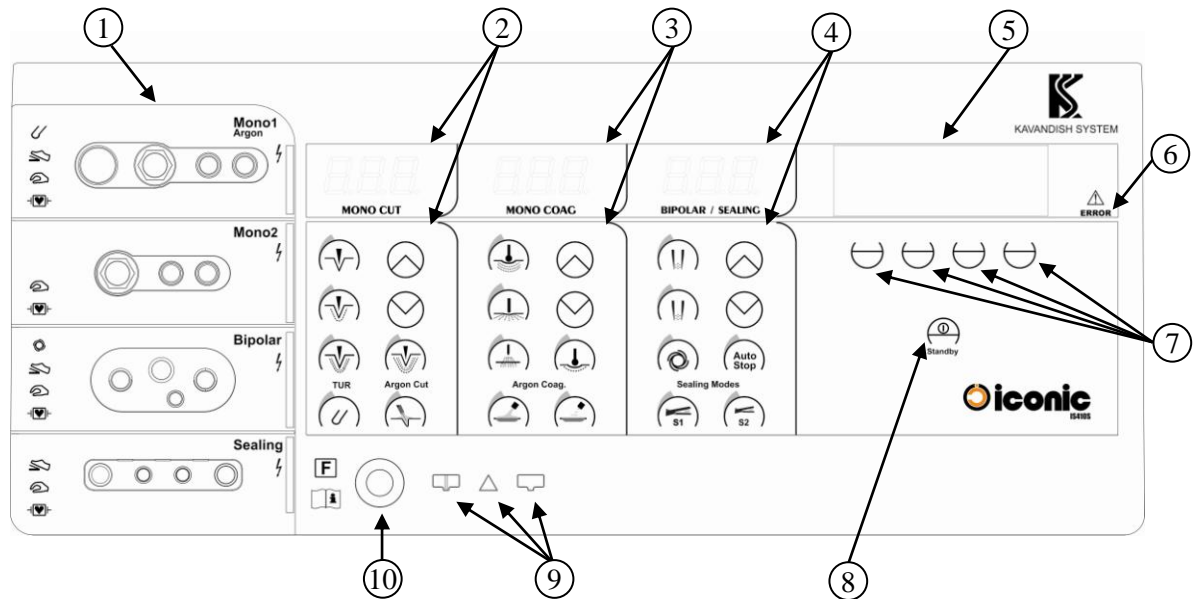

- ① Output receptacles section for connecting instruments
- ② Display and mode/ power settings section for Monopolar Cut
- ③ Display and mode/ power settings section for Monopolar Coag.
- ④ Display and mode/ power settings section for Bipolar/Sealing
- ⑤ LCD display
- ⑥ Indicator of all alarms except plate alarms
- ⑦ Four-key keypad
- ⑧ Standby button
- ⑨ Indicators of plate connection and related alarms
- ⑩ Single and dual plate receptacle (patient sheet)

Standby button has been designed for temporary system shutdown and setting the device in standby mode. In order to activate the standby mode, the button must be pressed for one second. In this case, the device does not receive any command and only it is out of this mode, it can respond to commands. To exit standby mode, simply press the button again for one second. When the device is in standby mode, previous information is retained and will be valid so long the device power is not interrupted. This information is stored in the device memory and upon exit from standby will appear on page displays.

## Back Panel Features

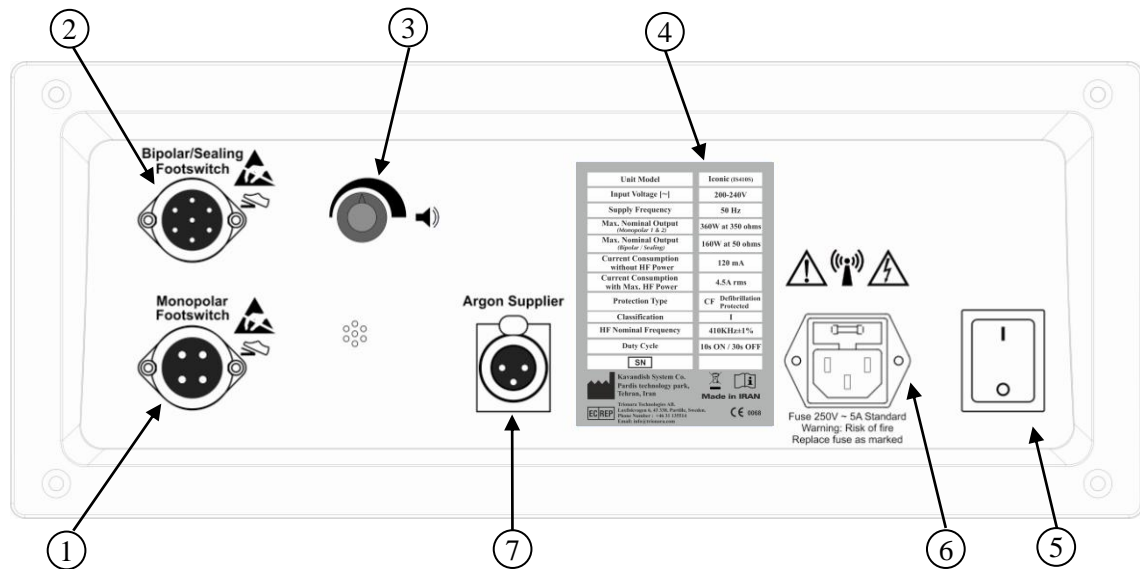

- ① Monopolar footswitch receptacle for connecting a two-pedal footswitch
- ② Bipolar/Sealing footswitch receptacle
- ③ Speaker volume control
- ④ Device identification label
- ⑤ Main (on/ off) power switch
- ⑥ Power cord receptacle and input fuse holder
- ⑦ APS1 argon supplier receptacle

## Signs Used on Front and Back Panels



The degree of protection against electric shock is of Cardiac Floating (CF) type and low frequency leakage currents are negligible. Also the device is protected against high voltage due to defibrillator use for patient.



Adjacent output connector can be activated with hand switch



Adjacent output connector can be activated with footswitch



Adjacent output connector may be activated automatically, only through electrode contacting tissue, without pressing footswitch or hand switch.



Hazard of high voltage in the adjacent output connector



Adjacent connector can be used for TUR surgeries



Plate and other applied parts such as Monopolar, Bipolar and Sealing instruments are completely isolated from earth and supply mains outlet at both high and low frequencies.



Study the instruction manual.

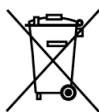

This device is marked with the WEEE symbol according to Directive 2002/96/EC. Devices marked with this symbol must be put into the separate waste collection for electrical and electronic devices. Please recycle where facilities exist.



Check with your Local Authority or retailer for recycling advice .



Caution

Study all related sections in User Manual and or Service Manual before installation and operation of the device and or opening it for repair.



There is the possibility of electromagnetic interference on surrounding electronic units.



High voltages warning



Electrostatic discharge warning for connectors sensitive to electrostatic discharge and precautions should be made when working with them.

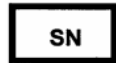

Device serial number



Manufacturer



Authorized representative in the European Community

# Chapter 2

## General Warnings and Safety Notices

- Launching and Using the Device
- Fire Hazard
- Electromagnetic Interference
- Accessories
- Monopolar
- Bipolar
- Sealing (Iconic IS410S Models)
- After surgery
- Repairing or Servicing

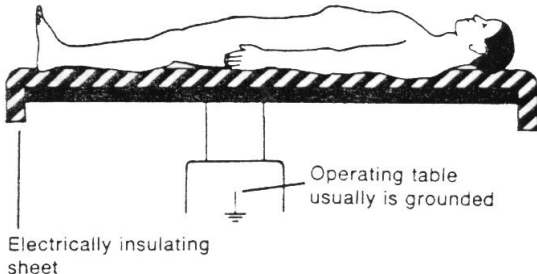

## Launching and Using the Device

WARNING
Study and follow all instructions and safety points provided with this manual.
Argon gas capability is supported by Iconic system using APS1 argon gas supplier device. For information regarding working principles of argon gas, advantages and its applications, APS1 installation and its connection to Iconic device, please refer to APS1 User Manual.
Check device performance in terms of appearance and safety alarms.
<b>Electric shock hazard:</b> use earthed outlets for connecting to supply mains.
In order to observe safety issues and avoid unwanted side effects, always use the lowest possible power which achieves the desired surgical effect. Of course in Continuous Argon and Pulsed Argon modes that the risk of gas embolism in lower power is increased, it's better to use higher powers.
Receptacles that are marked with electrostatic discharge warning symbol  (IEC 60417-5134), are sensitive to electrostatic discharge and precautions should be made when working with them. Thus, make ensure of lack of electrostatic load accumulation, when connecting cables to these special connectors. Typically accumulated static load can be discharged from device body.
The patient's body shouldn't be in contact with metal components connected to the earth or with significant capacitance to the earth (for example, metal parts of the operating table, metal base of injection device, etc.) or with moist or wet fabrics. This may cause burn due to high frequency leakage current and high density of current on small surfaces (antistatic sheet is recommended).
Since the elastic surfaces on the surgery bed usually have small amount of electrical conductivity to prevent electrostatic load accumulation; therefore, they're not suitable for complete separation of the patient from the metal parts. Use dry, waterproof and thick plates for separating the patient from the operating bed and metal items, use moisture absorption towels to prevent fluids concentration under the patient.
 <p style="text-align: center;">Method of positioning patient on the operating table</p>
Electrodes, monitoring equipment probes, irritant and imaging equipment can direct high frequency current leakage and therefore causes unwanted burn. Thus, when using high frequency electrosurgical device with these equipment; it's necessary that each electrode or monitoring probe be placed, if possible, far from surgical electrodes and patient plate and the minimum distance of 15 cm be observed between active electrode and ECG electrodes.
Using needle electrodes is not allowed for monitoring and if you're forced to use this type of electrodes, separate cables of needle electrodes from the monitor during electrosurgical device activation.
In any case it is recommended that high frequency current limiter monitoring systems is utilized.
In order to reduce the risks of high frequency current leakage from unwanted directions, use the following measures:
<ul style="list-style-type: none"> <li>• As much as possible use low voltage modes, like Pure mode that has lower voltage than Blend mode and also Soft or Swift modes that have lower voltage than Spray mode.</li> <li>• Avoid keeping the device active in open circuit mode that active electrode is not in electrical contact with tissues.</li> </ul>



<b>WARNING</b>
<p>In case you notice device output power is less than normal, check the following issues before increasing device power.</p> <ul style="list-style-type: none"><li>• Make sure that the desired position on the device panel, footswitch or hand switches are correctly selected.</li><li>• In Monopolar technique, make sure of correct and complete plate connection.</li><li>• Check cables and connectors connection to the device.</li><li>• Clean electrodes tips completely from adhesives material.</li></ul>
<p>If a failure occurs in the system, it is possible that device output power (in contrast with the selected power) increases.</p>
<p>If instruments are not used temporarily, keep them separate from surgery area and contacting with patient or conductive objects that are in contact with the patient. This prevents patient burn in case of unwanted device activation (due to accidental switch press).</p>
<p>Take the following steps to reduce the risks of minimally invasive surgery (such as laparoscopy) that sometimes burn occurs in the area not visible by the surgeon.</p> <ul style="list-style-type: none"><li>• Check insulation quality and note that any crack, gap and ripple can be a sign of insulation weakness and a direction for current leakage.</li><li>• Use minimum power and modes which uses minimum voltage.</li><li>• Active the generator just when active electrode is contacted with tissue.</li><li>• If active electrode is in the vicinity of metal parts or in contact with them, the generator should not be activated.</li><li>• Use Bipolar method whenever it is possible.</li><li>• If possible, use All metal cannula that external metal sheath covers all cannula system to reduce the possibility of leakage due to capacitated coupling.</li></ul>
<p>Do not wind instruments and plate cables around metal objects; this can cause current leakage through metal objects and also high frequency induction in these objects causes them to hot up and create burn.</p>
<p>Use isolated ocular parts in cases such as endoscopy and TUR and note that because active electrode is in constant contact with tissues, any unwanted activation of the generator can cause burn in the active electrode contact with tissue.</p>
<p>Avoid coagulation as long as possible in the method that between active electrode and hemostat instrument, electric arc is established. In this method, first contact metal to metal and then activate the generator, this reduces unwanted shocks to surgeons</p>
<p>Neuromuscular stimulation and following inadvertent consequences such as spasms or muscle contractions may occur in modes with high output voltage such as spray mode due to low frequency harmonics in electric arc. The device has been designed to minimize such stimulations.</p>
<p>If alarm is heard from the device, check the device status and make sure of its correct operation condition before reusing it.</p>
<p>To minimize adhesive effects of active electrodes to tissues during coagulation, do not activate the generator before electrode contact with tissue and stop the current upon sufficient coagulation and keep the electrodes always cleans.</p>
<p>Active electrodes may be hot due to electrical sparks and or contact with tissue during cutting and coagulation and their contact with other tissues can cause unwanted burn.</p>
<p>In cases the active electrode has constant contact with tissue even when the generator is not active, (eg. in endoscopy or TUR) more attention should be paid to visual and auditory signs of generator activation; and when there is no need to activate generators, for example during electrode take out from the patient's body, definitely set the output power displays in lack of output power mode or turn off the device.</p>

<b>WARNING</b>
In case generator is unwantedly activated and if electrodes are directly or indirectly through wet fabric or other conductor objects in contact with patient's body, it can cause burn. Unwanted generator activity can be due to accidental activation of pedal or hand switches or a failure in cable of accessories or the device itself; if connecting pedal or pen to device causes unwanted device activation, the failure is due to accessories, and if without connecting them to the device, generator is activated, the failure is due to the device. To avoid unwanted burns, never place active electrodes such that directly or through conductive objects or wet fabrics be in contact with patient.
Be careful in using of ESU in thin wall organs like intestine to avoid undesirable perforation. Set power as low as possible.
To prevent the staff's burn, avoid contact with patient during the activation of the ESU.
During activation, prevent patient body movement in the surgery site.

<b>CAUTION</b>
Some particles containing smoke and vapor are released in the environment due to surgery with electrosurgical device. The particles contain toxic chemicals, carbonized tissue, blood particles, bacteria and little amount of carbon dioxide. Therefore it is recommended to discharge the smoke by proper means and install suitable filters. Also the recommendations in this regard should be given to the operating room personnel and exhaust channels and open areas should not be used for smoke discharge. During surgery masks with high filtering effect with the lowest carbon particles inhalation must be used.

<b>NOTICE</b>
For ease in future follow-ups, register the device serial number in the patient's records.

## Fire Hazard

<b>WARNING</b>
There is the risk of gases or flammable substances combustion when using electrosurgical device. Thus, avoid the flammable substances contact with electrodes of electrosurgical device.
Use of electrosurgery in o <sub>2</sub> rich environments increases the risk of fire. Therefore, take measures to reduce the o <sub>2</sub> concentration at the surgical site. Avoid enriched o <sub>2</sub> , n <sub>2</sub> o atmospheres near the surgical site.
If the surgery is performed in the region of the head and chest, do not use flammable anesthetics or oxidant gases such as nitrogen oxide (N <sub>2</sub> O) and oxygen. If use is unavoidable, you must extract the combustion-supporting gases before performing electrosurgery.
There is the risk of flammable solutions accumulation under the patient or body's dimples such as umbilicus and body cavities such as vagina. It's better to dry any liquid accumulated in these places before using the device.
Avoid flammable gases that are naturally produced and are accumulated in body cavities such as intestines. Extract the flammable endogenous gases in the gastrointestinal tract before performing electrosurgery or irrigate with co <sub>2</sub> .
Some materials such as string, cotton and gauze when being saturated with oxygen, may be flamed when it comes to contact with sparks produced in the normal use.
If flammable disinfectant materials (those which have alcohol base) are used, let them being evaporated before covering the patient and avoid flammable material contact with electric arc during surgery.

## Electromagnetic Interference

<b>WARNING</b>
<p>There is possibility of electromagnetic interference between electrosurgical device and adjacent electronic devices. Therefore, in case of observing unusual condition in adjacent devices, consider the above possibility and apply special measures of electromagnetic compatibility to solve the interferences.</p>
<p>In case interference occurs only when the generator is activate, then following steps can reduce the interference:</p> <ul style="list-style-type: none"> <li>• Reducing the device output power.</li> <li>• Using low-voltage modes, for example Pure mode instead of Blend mode or Soft or Swift modes instead of Spray mode.</li> <li>• Using Bipolar technique instead of Monopolar technique.</li> <li>• Increasing the distance of device and its external cables from the unit which is affected due to interference (such as monitor).</li> </ul>
<p>If patient has pace maker or other electronic devices implanted inside the body, there is risk of interference in their performance and even damaging them. In such cases, if you have to use electrosurgical device, take the following actions to reduce the risk:</p> <ul style="list-style-type: none"> <li>• Use Bipolar technique as much as possible.</li> <li>• Check cables and their connections and connection of plate to the patient carefully to prevent spark due to connections weakness.</li> <li>• Select the plate location such that it is close to the operation area and heart or pace marker should not be positioned between plate and operation area.</li> <li>• Definitely consult with cardiologist before the operation</li> <li>• Use reliable monitoring equipment and continuously pay attention to ECG signals.</li> <li>• Defibrillator should be always available.</li> </ul>

<b>NOTICE</b>
<p>Iconic needs special precautions regarding electromagnetic compatibility (EMC) and needs to be installed and put into service according to the EMC information provided in the Iconic Service Manual and also this user manual.</p> <p>.....</p> <p>Portable transmitters and RF telecommunication can affect the electrosurgical device operation.</p> <p>.....</p>

## Accessories

<b>WARNING</b>
<p>Never use non-standard, poor quality, damaged and defective accessories and always make sure insulator of these devices is intact.</p>
<p>Do not leave the electrodes of other equipment (such as monitor) on the patient body. They can create a path for leakage current and cause burning.</p>
<p>It is better that whenever accessory is replaced, the proper power level is adjusted again regarding to new accessory.</p>

<b>WARNING</b>
<p>Using non-standard and defective accessories or using unauthorized accessories will be followed with the consequences listed below:</p> <ul style="list-style-type: none"> <li>• Unwanted generator activation</li> <li>• Generator break down</li> <li>• Injury or electric shock to the patient or surgery team</li> <li>• Inactivation of monitoring system of contact quality of plate to patient</li> <li>• Unwanted selection or mistake in surgical modes</li> <li>• Reducing or connecting and disconnecting output power</li> <li>• Electric shock or muscle nerves stimulation due to electric arc between two metals.</li> <li>• Electromagnetic interference in monitoring equipment (when the generator is activated)</li> <li>• Excessive high frequency current leakage</li> </ul>
<p>Never use accessories that their cable is rotted, tear or crushed or due to pressure or being coiled is deformed and sure that their pin is not broken.</p>
<p>Only use those instruments that can tolerate maximum output voltage (<math>V_p</math>) in each mode. For information regarding the maximum output voltage please refer to technical specifications chapter on page 74. In the related table maximum voltage is given as <math>V_{p-p} = (2 \times V_p)</math>. Using instrument with rated voltage less than maximum output voltage may cause damage to the patient, operator or the instrument. It's essential that rated voltage of each instrument be provided from its manufacturer factory.</p>
<p>It is recommended to use the accessories whose length up to 3 m.</p>
<p>Note that disposable accessories should not be used several times.</p>
<p>If you are not confident in the compatibility of your accessories, please contact Kavandish System Company or its approved representatives for their compatibility status.</p>
<p>Monopolar instruments must be connected to Monopolar receptacles and Bipolar instruments to Bipolar receptacle and Sealing instruments to Sealing receptacles and never to be mismatched.</p>
<p>All accessories must be placed securely and without need to high pressure</p>
<p>Never use converters for connecting accessories to the generator.</p>
<p>Never connect two surgical devices to an output receptacle simultaneously, because this will cause that both devices be simultaneously activated and inactivated.</p>
<p>Always keep surgery electrodes clean. Necrotic tissue remaining on the electrodes increases the path resistance and reduces optimal performance. Also note that the electrodes can get hot at the time of device activation. Therefore, after inactivating the device, the electrodes shouldn't have any contact with patient's body.</p>
<p>Electrosurgical accessories should be positioned such that their unwanted contact with patient or with each other is avoided. Active electrodes that are not used should be kept separate from the patient. Also, cables connected to the surgical instruments are better to be placed in a direction that avoided contact with patient or any other conductive object so that the risk of unintended burn is reduced.</p>

### **CAUTION**

It's essential that placing and removing accessories connectors from the device are done slowly and gently and high pressure to cables and connectors should be avoided.

Avoid wrapping instrument cable tightly, with pressure, and also around the instrument; because this may cause cable deformation in the long run.

### **Footswitch**

#### **WARNING**

**WARNING**

It must be noted that footswitch should not be used in the region 25 cm from areas that are likely to leak flammable anesthetic materials. This area is known as Medical Zone which is shown in figure below.

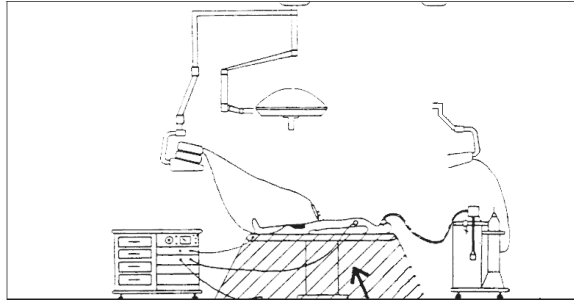

The area that only protected switches from fire hazard can be used.

Use non-flammable substances for cleaning and disinfecting footswitch.

**NOTICE**

Never use footswitch cable for footswitch transportation

Avoid applying pressure to the cable connection to the footswitch.

Avoid wrapping cable around footswitch firmly and with pressure.

**Monopolar****WARNING**

Prevent skin to skin contact (for example between arms, the patient's body or thighs). For that purpose a towel or dry gauze can be used. Also, the parts of patient's body that have excessive sweating and there is the possibility of having contact with other parts of the body, should be kept dry with a towel.

Note that if two surgeons activate Monopolar1 and Monopolar2 outputs simultaneously in Spray mode, output power is divided between the two surgical pens. So, power connection or disconnection in one Monopolar pen can affect on the other output power.

**Plate****WARNING**

Correct use and proper placement of plate is one of most important points in effective and safe use of Monopolar electrosurgery.

Kavandish System Company suggests using dual plates to increase patient safety. In case of single plate use, contact quality of plate with patient will not be monitored by the device.

In case of using polymer plates, definitely use silicon and standard types. Non-standard rubber plates with unknown brands can cause burn. Worn and old polymer plates will lose its quality over time

**WARNING**

Select kind and dimension of plate according to the table related to the minimum surface required for plate on page 27 and output power. And place the plate such that a suitable contact surface is established between itself and the patient's skin. If the effective contact surface is low due to weak and imperfect contact, it could cause burn resulting from current density increase in contact area.

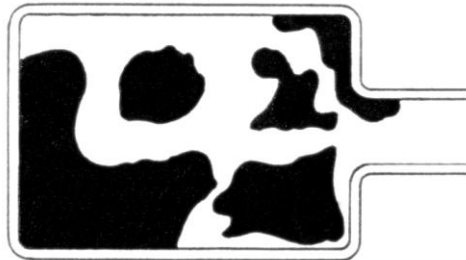

Reduction of effective plate area

□ Electrical current conductor area

■ An area that doesn't conduct electrical current since it has no contact with skin and because of being oxidized or contaminated with lipid particles has a weak conductivity.

Increase electrical conductivity of the skin of patient's body that neutral electrode is placed on it through cleaning, massaging to increase blood circulation in skin and shaving hair of contact area.

Avoid placing plate on hypodermic large blood vessels or bones or parts that blood circulation is usually weak.

In permanent plates, use proper gel uniformly on all plate surfaces. Fix plate position using rubber bands and wrapping band around it so inner surface of plate has good connection in patient skin and in case of moving the patient, check correct plate connection again.

If gel is not used, be careful that during surgery, any fluids or moisture due to bleeding, or washing or disinfectant liquids or patient's body sweat does not reach the plate. Due to penetration of those liquids to plate, may increase the possibility of burn in the area

All over the current conductive area from plate should be fixed, in an appropriate location that blood circulation in that area is normal (such as upper arm and thigh), in the closest area to the operation position. Such that direction of current flow between the plate and Monopolar active electrode be the short possible path and as much as possible does not pass through heart and lungs.

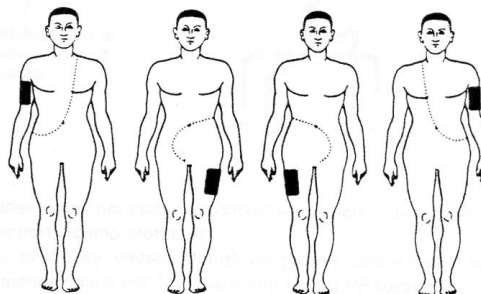

Never use water, salt water solution or wet fabric for strengthening plate to patient contact.

In case electrically conductive parts are placed inside the patient's body, choose the plate location such that those parts are not in the current path.

Never deform patient's plate against the manufacturer's instruction and note that they're not torn or interrupted.

Always make sure that cable insulation of neutral electrode is intact.



**NOTICE**

It is recommended that plate position and patient's skin condition is recorded in patient document before plate placement.

**Bipolar**

**WARNING**

Based on advantages of Bipolar technique that are expressed below; it is recommended to use Bipolar techniques in all practical possible cases which the area of current flow in body is small.

- In Bipolar technique, due to the limited area of the current effect region which is small area between the two tips of forceps, it requires lower output power, and no need for plate. Therefore it has much less burn hazards than Monopolar technique and also prevents unwanted coagulations.
- In Bipolar technique, due to smaller current flow through tissues and lower output power, possibility of electromagnetic interference in electronic devices is much less than Monopolar technique.

One of Bipolar technique problems is tissues adhesion and blood clots on the two forceps' tips. This issue sometimes causes recurrent bleeding when removing forceps from the tissue. To minimize the effects of adhesion, please consider the following:

- If the system is enabled before electrode-tissue contact, the first spark between the electrode and the tissue can cause tissue carbonization and sticking tissue to the electrode. Thus as far as possible, do not enable Bipolar generator before electrode-tissue contact. For this purpose, use Auto Start mode with or without delay.
- Keeping forceps on the tissue for a long time can cause tissue carbonization which itself causes tissue to stick to the forceps. Therefore disable the generator once the sufficient coagulation is done. And avoid continuing coagulation process without having beneficial effect (It is suggested to use Auto Stop mode).
- Always keep electrodes clean and after each use completely remove effects of tissue adhesion due to the previous coagulation.
- If dry tissues are operated under Bipolar technique, moist them with sterilized water or physiological salt solution previously.

Whenever during Bipolar surgery, the electrode sticks to the tissue, before separating the electrode from the tissue deactivate the current and wait for a few seconds so that capillaries discharge and adjacent tissues reduce the adhesion effects. In more severe cases, sterilized water or physiological salt solution can be used.

If Auto Start mode is selected, necessary precautions should be made. Since if electrode contacts with the tissue, the generator will be automatically activated.

**CAUTION**

During coagulation, electrodes surface are covered with tissue fluids. While the fluids are being dried, it can prevent full electrical current flow through the electrodes surface and the surgeon feels the output power is low. This problem will be resolved by cleaning the electrode after each coagulating.

**Sealing (Iconic IS410S Models)**

**WARNING**

Do not use this technique so long you haven't learned how to use the device in Sealing technique and have not learned procedure of using related surgery instruments in this technique. Using the device without training could have adverse results.



<b>WARNING</b>
Using Sealing technique is not appropriate for tubal sterilization or tubal coagulation for sterilizing processes.
For patients with particular vascular problems such as atherosclerosis or aneurismal vessels, seal positions must be selected on healthy vessels.
Using the wrong mode when working with a surgical instrument causes either no sufficient reliability for seal quality or damage to the tissue due to excessive heat.
In order to apply the required mechanical pressure during sealing, surgical instrument must be completely locked. Otherwise, created seal will not be reliable.
Tissue close to the jaw hinge of surgical instrument and outside the two jaws will not be sealed (even if it turns white by applying energy).
Conductive fluids such as blood or saline in the vicinity or direct contact with surgical instrument can transfer heat and electrical energy to adjacent tissues. Thus, dry sealing area before starting the process.
Surgical instruments must be completely dry and fully connected to the generator
External surface of surgical instrument may be too hot after the end of the process. Be careful of contacting and damaging to other tissues.
Do not activate the generator when jaws of surgical instrument are adjacent to a metal tool. In this case it is possible that energy is not transferred to the tissue or the patient or doctor is being injured.
Note that during sealing process, the power level cannot be changed. Therefore before starting the process, be assured of the desired power level setting and the selected mode.
In case of observing any spark, immediately stop the surgery and check all connections of the generator and electrode. Metal to metal spark can cause patient neuromuscular stimulation.
To create a seal with good quality, It is better to place vessels with their surrounding tissue in the jaws of surgical instrument. Thus the created seal will show more strength.
During sealing process, the vessels should not be under tension or mechanical pressure. The reason is that in the condition that vessel wall begins to melt and change its condition, the slightest tension causes distortion and separation in wall structure which results in bleeding.
Cleanness of surgical instruments surface has an important role in proper and appropriate energy transfer to the tissue and completing sealing process.
Frequent use of disposable surgical instruments causes tissue adhesion to the electrode, creating electric arc, and reducing seal quality

#### **NOTICE**

-----

If during Sealing technique activation, Monopolar technique activation is demanded. Monopolar will not be activated and Sealing continues.

-----

Do not apply additional hand force to the lever during sealing to ensure proper function. If the lever cannot be unlatched following use, open the device by forcing the lever forward from the handle.

-----

### **After surgery**

<b>WARNING</b>
Gently, open the communication cables from connectors.
Gently, separate the plate from the patient and see plate to patient contact area to investigate any possible injuries and burn.

**WARNING**

If possible, for cleaning and disinfecting the device use non-flammable materials.

In case you have to use flammable materials for cleaning and disinfecting the device, wait a while until these materials are completely evaporated, before turning the device on.

Sometimes, other factors rather than increase of electric current density cause necrosis. It should be noted that such factors should not be mistaken with burns caused by electric current density increase that only occur at patient connection with metal objects or incomplete plate to patient connection area. One of those pseudo burns is chemical burns which caused by prolonged tissue contact with disinfectants material. Another kind of those pseudo-burns is related to tissue being under pressure during surgery. Tissue necrosis may occur in patients who undergo surgery for a long period of time (such as open heart surgery or neurosurgery) or after they stayed in ICU under anesthesia or with no movement. To prevent such necrosis, adequate care must be taken to avoid placing patient's tissues under prolonged pressure which could prevent supplying proper blood to tissues. Also despite the burn caused by electrosurgical device which shows itself immediately or one hour after surgery, the signs of those pseudo-burns may show themselves hours or even days after surgery.

**NOTICE**

Penetration of liquids into the device can cause damage to it; Since there is the possibility of liquids penetration from its bottom side, observe necessary precautions during cleaning and disinfecting the device.

The expected service life of the device is 10 years. Do not dispose of this device in the unsorted municipal waste stream. It should be placed in separate waste collection for electrical and electronic devices. Always comply with the national regulations of the relevant country when disposing of or recycling the device or its components.

**Repairing or Servicing****WARNING**

**Danger of electric shock:** Never open the device case. Any modification or repair on device must be done by authorized service personnel from Kavandish System Company.

# Chapter 3

## Installation and Launching

- Before Launching
- Turning on the Device
- Checking the Device before Using in Operating Room

## Before Launching

1. After opening the device package, please check the physical condition of device and its accessories. In case of damage due to transport or any other cause, please contact Kavandish System Company and notify failure type, device serial number, and your address.
2. Place the device on a fixed flat and with no vibration surface.
3. Connect the device to electric network (200 V to 240 V or 100 V to 130 V depending on delivered system) via power cable.

### WARNING

To ensure compliance with safety issues and suitable earth for the device, use earthed outlets for connecting to supply mains.

### NOTICE

Selecting a suitable location for the device can prevent system damage and injury.

## Turning on the Device

1. Turn on the device using the main power switch (on the back panel).

### NOTICE

To avoid receiving any false errors, all accessories should be kept detached from the system at turn on time and during the self check of the device.

2. Observe and check the following when the device is turning on and during self checking (testing different parts of the device).
  - First, all segments of LCD display and 7-segments are lit up respectively.
  - Then Monopolar Cut, Monopolar Coag., Bipolar, and Sealing techniques and all related modes are checked and the corresponding LED will be on. Concurrently the software version number of the device along with the date and its edition also appears on the LCD display.
  - After checking, if any technical problem is observed in the device, the error code is issued and is visible on the LCD display as shown in below figure.

<p>SELF CHECK REPORT</p> <p>Error Codes are:</p> <p>02, 12, 22</p>
--

In such case please refer to alarm code tables on page 64, to find more information about types of error. In case the reported failures are not of concern by user then press of any button will take the system to the ready to operating mode. Obviously the modes in which failure has been reported will not operate correctly.

But if after complete checking of the device no problem is observed, and then message of “no errors reported” will be display on LCD as shown on below figure.

<p>SELF CHECK REPORT</p> <p>No errors reported</p>
--

- Then “welcome to Iconic” message will appear on the LCD as shown below.



At this time the information already stored in memory number 30 appears on the panel flashing. This memory contains program which already stored in by the company as default program.

In this condition press of any button will take the system to normal operating mode and is ready to work. After entering the normal operating mode, if the plate is not connected to the device “Er:PT” alarm is generated (see alarm conditions on page 61).

### Checking the Device before Using in Operating Room

If you turn on the device for the first time, before using the device in the operating room, test the performance of the device using the following instruction:

1. First, turn on the device and observe Self Checking processes according to the previous section. After entering the normal operating condition, mode adjustment and power setting must be according to default condition (memory 30). At this stage, the LCD displays the selected modes.

#### NOTICE

“---” condition in power displays is the sign of not selecting power in the output.

2. Carefully check all device accessories including each technique instruments, plate and footswitches, if they are ok, connect them to the device.
3. If normal single plate is connected to the device; LED indicator of single plate connection must be on. If normal dual plate is connected to the device, and if it is completely contacted with tissue, LED indicator of dual plate connection must be on. Otherwise, alarm LED related to lack of proper plate connection will be on and corresponding alarm will be generated.
4. For activating Monopolar, put a piece of raw meat (or raw fruit, or a bar of soap or a piece of damp cloth) on the plate and by pressing hand switches on Monopolar instrument or corresponding footswitch, activate Monopolar Cut and Monopolar Coag. techniques and apply the output to the raw meat through Monopolar instrument. Each time by activating generator, LED associated to the activated technique will be on and continuous sound of speaker will be heard. Simultaneously, information about selected technique and mode, generator activation type and alarm (if any) appears on the LCD monitor. Do this test for both Monopolar outputs.
5. Change power levels in Monopolar Cut and Monopolar Coag. and by output activation, see the output power variation on the raw meat.
6. In Bipolar technique, by pressing hand switch on Bipolar instrument or corresponding footswitch, apply the output on the raw meat through the instrument. Do this for both Bipolar Cut and Bipolar Coag. techniques (by setting them through corresponding buttons) and repeat it for different power levels.
7. Select Auto Start mode for Bipolar Coag. technique and put Bipolar instrument on raw and damp meat. In this mode Bipolar generator automatically, with 0 to 2.5 seconds delay depending on the selected value (see how to set delay on page 56) is activated.
8. In case of Sealing technique (in Iconic IS410S models) for both Seal1 and Seal2 modes, by pressing hand switch on Sealing instrument or corresponding footswitch, apply the output to the raw meat through the instrument.

# Chapter 4

## Monopolar Technique

- Information Regarding Monopolar in Receptacles Module Section
- Monopolar Receptacles and their Accessories
- Patient Plate
- Footswitch
- Capability of Using Argon Gas
- Information Regarding Monopolar Cut in Mode and Power Setting Section
- Monopolar Cut Modes
- Information Regarding Monopolar Coag. in Mode and Power Setting Section
- Monopolar Coag. Modes
- Power Level Changes in Monopolar
- Output Power Selection in Monopolar
- Method of Monopolar Cut Setting
- Method of Monopolar Coag. Setting
- Method of Using Monopolar

### Information Regarding Monopolar in Receptacles Module Section

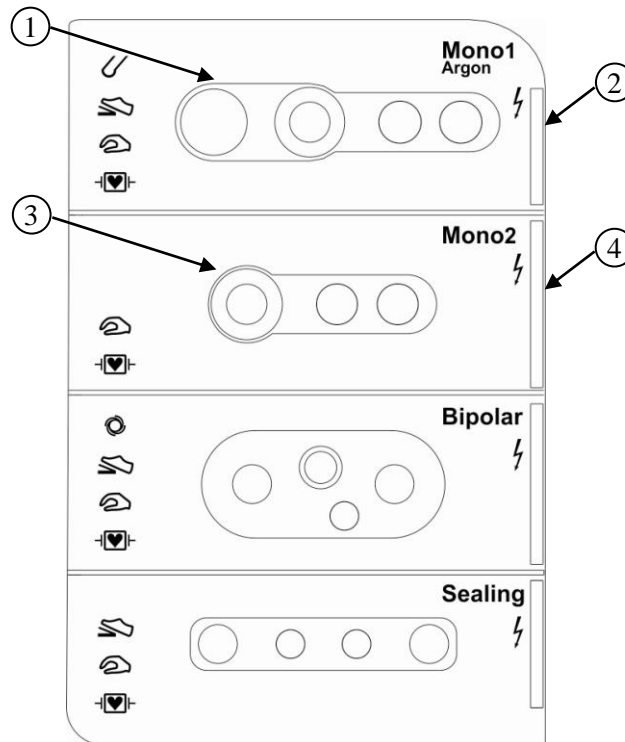

- ① Monopolar1 instruments receptacle
- ② Indicator of Monopolar generator activation and receiving output via Monopolar1 receptacle
- ③ Monopolar2 instruments receptacle
- ④ Indicator of Monopolar generator activation and receiving output via Monopolar2 receptacle

### Monopolar Receptacles and their Accessories

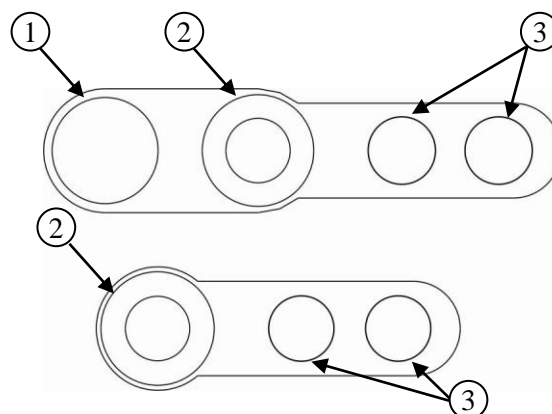

- ① 8 mm connector
- ② 4 mm coaxial connector
- ③ 4 mm normal connectors

The high frequency main current path is from 8 mm connector and core of 4mm coaxial connector. 4mm normal connectors and 4 mm coaxial connector outer shield are used for hand switch connections.

#### NOTICE

Use of output along with argon gas (in argon modes) is possible only via Monopolar1 receptacle





## Monopolar Instruments

### WARNING

Kavandish System Company recommends only using Monopolar instruments within the device package which are approved by its quality control department or from the following companies: Bowa, Fiab, Martin, Tecno and Metko.

In the Iconic product, you can use various Monopolar instruments with variety of connectors. Specifications of those connectors are presented in below table.

**Table 1 Types of Monopolar Connectors**

Instrument Connector	Activation Type	Iconic Monopolar connector	Description
<p>1-pin connector with 8 mm plug</p> 	Footswitch	8 mm connector	In addition to Monopolar pen, this connector can also be found on devices such as endoscopy, laparoscopy and TUR
<p>Connector with 4 mm coaxial plug (Martin type)</p> 	Footswitch and hand switch	4 mm coaxial connector	--
<p>1-pin connector with 4 mm normal plug</p> 	Footswitch	Core of 4 mm coaxial connector	In addition to Monopolar pen, this connector can also be found on devices such as endoscopy, laparoscopy and TUR
<p>3-pin connector</p> 	Footswitch and hand switch	Core of 4 mm coaxial and 4mm normal connectors	--

### WARNING

When Monopolar is active, all output connectors of the relevant Monopolar receptacles and pens connected to these connectors have voltage. Therefore necessary precautions should be made and never connect two pens to a Monopolar connector simultaneously.

### NOTICE

Use auxiliary connectors just for 3-pin pens. 1-pin connector instruments should not be connected to those connectors. Such connection could damage the Monopolar receptacle.

Only Monopolar instruments which is connected to Monopolar1 receptacle can be activated by footswitch



Monopolar instruments are activated in two ways. Some instruments have hand switches which can be activated either this way or by footswitch. Other instruments don't have hand switch and can only be activated by footswitch.

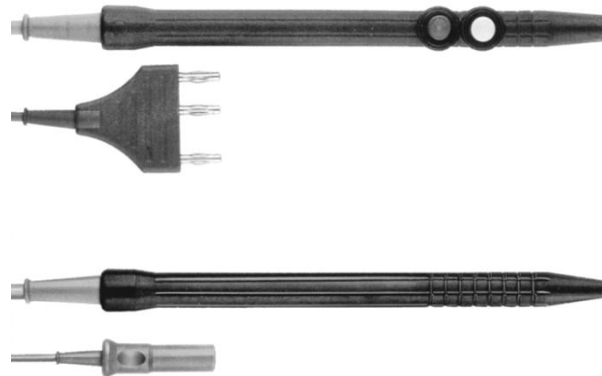

Usually, there are two push buttons on Monopolar instruments using hands witches; the surgeon selects cutting mode by pressing yellow button which is closer to the tip and coagulation mode by pressing blue button.

#### WARNING

Note that cables and Monopolar pens must have sufficient insulation to withstand output voltage of device (according to maximum output voltage graphs on page 74). To ensure this, it's necessary to refer to documents associated with Monopolar pen. The importance of this issue is higher in high voltage modes like spray mode; in those modes, damage or weakness of cable and pen insulation can cause unwanted effects and burn.

Monopolar cable and pen are not repairable and in case of damage a new pen must be used.

#### Monopolar Electrodes

Various types of electrodes of different shapes and sizes are used as an active electrode in Monopolar surgery. Those electrodes are installed on Monopolar pens. Electrode installation and replacement are easily done and the surgeon can choose their intended appropriate direction by rotating each electrode.



Some types of electrodes such as knife electrodes are provided with the device which covers common surgical uses. However, the surgeon may use other types of active electrode which can be installed on Monopolar pen depending on their needed specific mode.

**NOTICE**

To prevent electrode damage, always use appropriate boxes for storage and transportation.

**Patient Plate**

In Monopolar technique, the current enters the patient body through Monopolar pen electrode, and returns back to the device through plate (neutral electrode). Plates are in different types of single and dual. Those types of plates can be connected to Iconic plate receptacle using 6.3 mm diameter connector.



**WARNING**

Kavandish System Company recommends only using plates within the device package which are approved by its quality control department or from the following companies: Bowa, Erbe, Fiab, Martin, and Shuyou.

**Plate Indicators on the Panel**

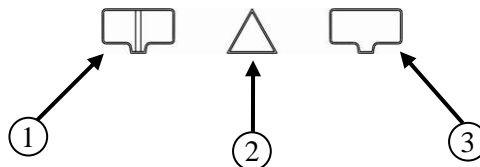

- ① Indicator of dual plate connection
- ② Indicator of plate alarms
- ③ Indicator of single plate connection

If a single plate is connected to the device, indicator of single plate connection and if a dual plate is connected to the device, indicator of dual plate connection turns on. If any alarm is detected related to plate (see alarm conditions on page 61), the indicator of plate alarms related to lack of appropriate connection turns on and the two indicators of plate connection turns off.

**Patient Plate Monitoring System**

Reduction of surface contact of neutral electrode or its weak connection to patient body can increase current density and thus may cause burn on contact place. This device is equipped with patient plate monitoring system and thus reduces the burns caused by inappropriate plate connection to patient body.

Patient plate monitoring system permanently (both in active and inactive state of generator) measures plate resistance with  $100\text{kHz} \pm 10\text{kHz}$  frequency. Based on plate resistance, plate type and its connection quality to body are determined. Therefore, the following three cases may occur:

- If resistance is less than 25 Ohms, it will be detected as a single plate. In this case, because of using a single plate, quality of plate connection to patient cannot be investigated.
- If resistance is between 25-150 Ohms, it will be detected as a dual plate and monitoring system is able

to investigate the quality of plate connection to patient. In this case resistance changes are also calculated in addition to resistance in order to investigate changes in quality of plate connection to patient. And if the measured resistance at any time increases more than 50 percent relative to the minimum measured resistance, a poor connection quality is considered and the alarm of plate problem is generated by alarm system. Of course resistance changes are only investigated in the inactivity state of Monopolar due to because of possible impact of generator noise on plate circuits. Generator active state is short and the probability of changes in the plate connection status in short times is too small.

- If the resistance is higher than 150 Ohms, Then either the plate connection to body or device is not established, or the connection quality is low. In this case, the alarm system generates plate problem alarm.

Consequently, plate monitoring system is able to detect the inappropriateness of plate condition and automatically take the following actions:

- If the plate is not connected to the device or any damage occurs in the cable and plate connector path to the device which disconnects the connection path; appropriate alarm is generated and prevented from activation or operation continuation of the Monopolar generator.
- If dual plates are used, the appropriate plate connection to patient is investigated and if the effective contact area is not enough, the suitable alarm is generated and prevented from activation or operation continuation of the Monopolar generator.
- If dual plates are used and Monopolar generator is inactive, changes in plate connection to patient are investigated and if those changes are higher than adequate level, the suitable alarm is generated and prevented from Monopolar generator operation.

**WARNING**

In dual plates, its effective contact area to patient body is of great importance and if there is any problem in the quality of plate connection to patient body, the device will sense it and generates the alarm.

Using dual plates extensively reduces unwanted burns in plate location.

### Material and Dimension Selection of Patient Plate

Choosing material and dimension of patient plate depends on the used output power. In the following figure the minimum required surface area for different types of plates is shown.

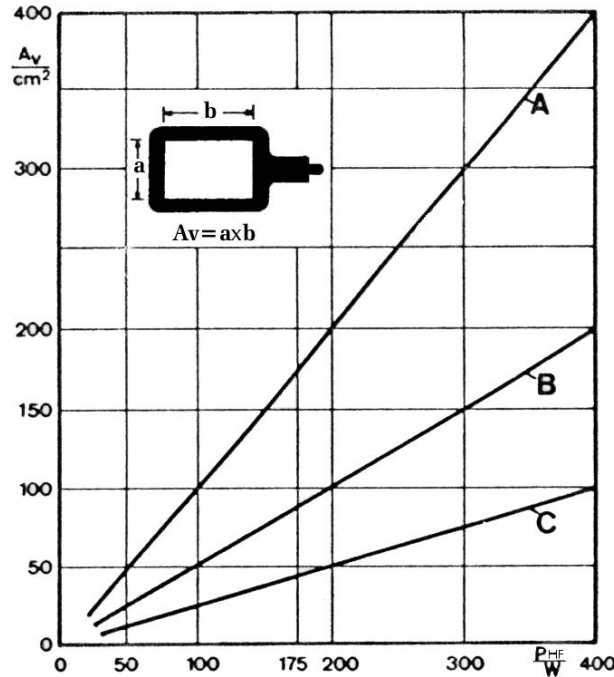

- A: patient plate is made of silicon rubber.
- B: patient plate is made of stainless steel without using electrical current conductor gels.
- C: patient plate is made of flexible metal plate with using electrical current conductor gels or disposable plates having current conductor gels or sticky gels.

**WARNING**

For patient safety, it is necessary to use the minimum required contact surface area for patient plate based on the maximum output power used on each patient.

### Footswitch

In order to use footswitch in Monopolar technique, it is necessary to connect a two-pedal footswitch to the Monopolar footswitch receptacle on the back panel. In this case, by pressing yellow pedal, Monopolar Cut and by pressing blue pedal, Monopolar Coag. will be activated.

The two-pedal footswitch provided with the device is as follows:



**WARNING**

Kavandish System Company recommends only two-pedal footswitch within the device package which are approved by its quality control department.

### Capability of Using Argon Gas

Capability of using argon gas for surgery has been provided in Iconic device. For this purpose, APS1 argon gas supplier device has been designed and made for Iconic support. APS1 is responsible for controlling and argon gas directing to the surgical probe. Argon gas exiting from the tip of the surgical probe, by placing high voltage between the electrode tip and tissue surface, argon gas is ionized and direct path with low impedance for electric current passing is created as argon gas plasma. The ionized gas flow in this case will have brightness with special blue light. Generally argon system is used for both coagulation and cutting. However argon application is very limited in cutting and its main application is surface coagulation. Argon gas used in surgery has many advantages, some of which include:

- The ability to control argon ray and therefore controlling energy position apply and reducing adjacent tissue damage.
- Reducing electrode adhesion to the tissue due to probe distance from tissue surface
- Reducing odor and smoke surgery due to removing oxygen from surgery position
- The possibility of tissue surface coagulation (between 1 mm to 3 mm) with high speed and in aboard and uniform surface

**WARNING**

For using argon gas capability, provide APS1 argon gas supplier device for supporting Iconic device and for information on principles of argon gas working, its advantages and applications, APS1 installation and launching and connecting it to Iconic refer to the User Manual of APS1 device.

**Information Regarding Monopolar Cut in Mode and Power Setting Section**

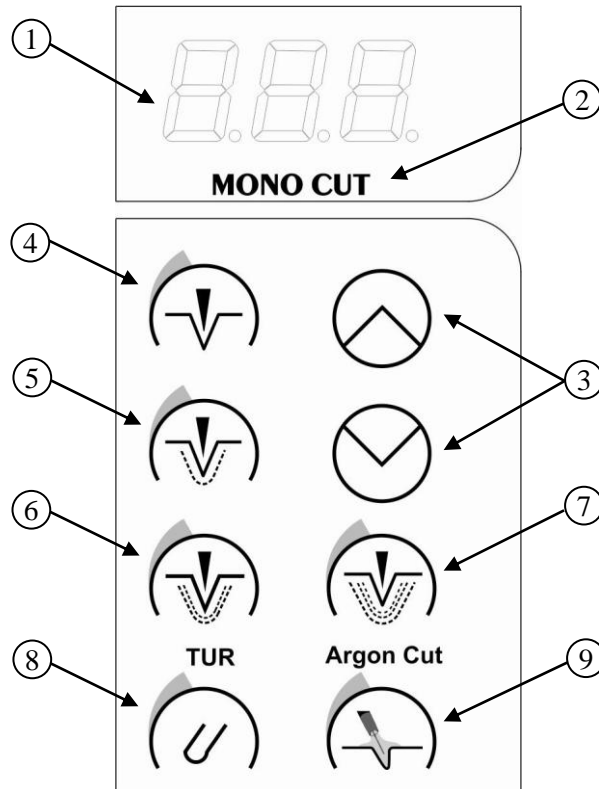

- ① Display of Monopolar Cut output power
- ② Indicator of Monopolar Cut activation
- ③ Monopolar Cut output power settings buttons
- ④ Button and indicator of Pure mode selection
- ⑤ Button and indicator of Blend1 mode selection
- ⑥ Button and indicator of Blend2 mode selection
- ⑦ Button and indicator of Blend3 mode selection
- ⑧ Button and indicator of TUR mode selection
- ⑨ Button and indicator of Argon Cut mode selection

Output power will change in certain step by each press on output power setting buttons or keeping a finger on them.

## Monopolar Cut Modes

**Pure:** This mode provides pure and smooth cut with minimum coagulation in surrounding tissues. In this mode damage to the surrounding tissues during cutting is minimal.

**Blend:** In this mode in addition to cutting, the tissues adjacent to electrode will be coagulated. 3 blend degrees exist for controlling coagulation depth of adjacent tissues during cutting. By increasing the blend degree from Blend1 to Blend3, the rate of coagulation of adjacent tissues will be greater. In Blend3 tissues adjacent to cutting area will be more coagulated than other cut modes. As a result, this degree is suitable for cutting tissues with excessive bleeding and tissues with fat layers.

**TUR:** This mode has been prepared for surgery in fluid environments such as bladder and prostate. It will be activated along with one of the optional modes of Pure, Blend1, Blend2 and Blend3 as a complementary mode to create clinical effects of those four modes in fluid environment operation.

**Argon Cut:** This mode has been prepared for cutting tissues along with argon gas. It will be activated along with one of the optional modes of Pure, Blend1, Blend2 and Blend3 as a complementary mode to create clinical effects of those four modes with argon gas. Using argon gas with cutting creates a clean cut along with smooth coagulation for the surgeon. The mode can be used for cutting tissues with high impedances such as cartilage (please refer to User Manual of APS1)

### Notice

-----  
Since Argon gas can only be used via Monopolar1 receptacle, in case the Argon Cut is selected but needs to use Monopolar2 receptacle, then the selected output is activated as complimentary mode (one of Pure, Blend1, Blend2, and Blend3 modes) without Argon gas.  
-----

**Information Regarding Monopolar Coag. in Mode and Power Setting Section**

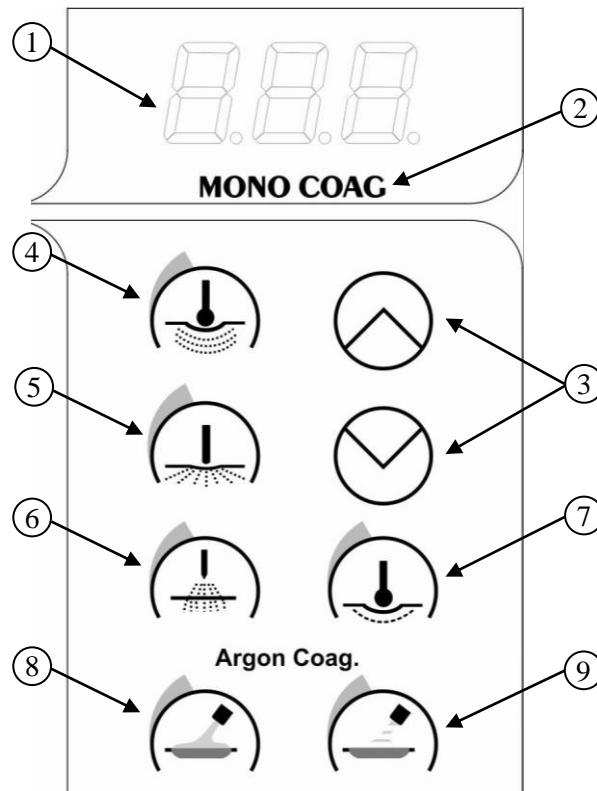

- ① Display of Monopolar Coag. output power
- ② Indicator of Monopolar Coag. activation
- ③ Monopolar Coag. output power setting buttons
- ④ Button and indicator of Swift mode selection
- ⑤ Button and indicator of Forced mode selection
- ⑥ Button and indicator of Spray mode selection
- ⑦ Button and indicator of Soft mode selection
- ⑧ Button and indicator of Continuous Argon mode selection
- ⑨ Button and indicator of Pulsed Argon mode selection

Output power will change in certain step by each press on output power setting buttons or keeping a finger on them.



## Monopolar Coag. Modes

**Swift:** This mode is used for rapid coagulation of tissues using electrodes with relatively large cross section such as ball, plate electrodes or forceps (the surgeon takes the position with forceps and contacts the active electrode to it).

**Forced:** This mode is used for deep coagulation of tissues using electrodes with small cross section.

**Spray:** This mode is used for coagulation of tissues surfaces with low depth without contacting the electrode with tissue. The main feature of this mode compared to others is its more electric arc intensity and the possibility of coagulation by the use of electric arc without direct contact of electrode with tissue. This mode is appropriate for minimizing the effects of cutting and tissue separation. If this mode is selected, the two Monopolar1 and Monopolar2 outputs can be activated simultaneously; whereas in other modes in the case of demand for activating two Monopolar outputs, priority is given to Monopolar1 and Monopolar2 will not have output.

**Soft:** This mode is used for soft coagulation of tissues without carbonization and adhesive effects of tissue to electrode. In this mode, the output power is lower than the three previous modes.

**Continuous Argon:** This mode is the most popular and practical method for electrosurgery using Argon. In this mode continuous electric current along with Argon gas is applied to tissue. In general, this mode is applied for cases which continuous coagulation is needed in a large area with high speed. The common mode for coagulation of tissue surface is Spray Mode. But due to lack of control in accidental movement of electric arc, there is possibility of damaging the normal tissues in surrounding coagulation area. While using Argon gas helps to remedy the above problem (please refer to APS1 device User Manual).

**Pulsed Argon:** In this mode, the electric current is applied to tissue in form of pulse along with Argon gas. This mode compare to the previous one, the energy applied to tissue is reduced and creates lower coagulation. In general, the pulse is used when low argon gas power and depth is needed. Therefore, the tissue destruction (creating whole or tear in tissue) is minimized. This mode mostly used in laparoscopy and for thin and sensitive tissues (please refer to APS1 device User Manual).

### Notice

Since Argon gas can only be used via Monopolar1 receptacle, in case one of Continuous Argon or Pulsed Argon modes selected, but the activity from Monopolar2 receptacle is requested, then the output would be activated according to Spray mode without Argon gas. In this case regarding patient's safety, if the adjusted power for Spray mode is more than adjusted power for argon mode, Spray mode will be activated with the argon mode power.

## Power Level Changes in Monopolar

In Iconic, Monopolar adjustable power level is divided into different ranges. Step of power level changes in various ranges is different:

- Range 1: from 0 to 50 with step1
- Range 2: from 50 to100 with step 2
- Range 3: from 105 to 200 with step 5
- Range 4: from 200 to the end with step 10

## Output Power Selection in Monopolar

Selecting the appropriate output power value in Monopolar technique is one of the most important effective factors in cutting and coagulation quality. Optimal power value depends on different factors such as geometry of the used active electrode, speed of surgeon's hand, the way of electrode movement on tissue, tissue characteristics, and selected current waveform.

Although power selection completely depends on surgeon's experiences and opinion; but following considerations are recommended for appropriate power selection:

- In Pure mode, in the case of using needle or lancet electrodes which have small diameter, lower powers and with larger diameter electrode such as knife electrodes, higher powers should be used.
- In fat tissues cut, the selected power must be greater than for other tissues cut due to the increased electrical resistance of those tissues.
- Since there are layers of dried blood and tissues on surfaces of dirty electrodes, which prevents sufficient current flow, there is a need to select excessive power. To prevent using excessive power; it is necessary to keep the surface of active electrodes clean.

## Method of Monopolar Cut Setting

1. For setting Monopolar Cut technique on each of Pure, Blend1, Blend2, Blend3, TUR, or Argon Cut modes, press the corresponding button until its LED indicator is on.
2. If TUR or Argon Cut mode is selected, for complementary modes among Pure, Blend1, Blend2 and Blend3, press the corresponding button until its LED indicator is on.
3. Power value of the current mode is displayed in Monopolar Cut power display. Press the power set buttons to change the value. Power value will change one unit by each time you press on the buttons. To speed up power value change, keep your finger on the button.

## Method of Monopolar Coag. Setting

1. For setting Monopolar Coag. technique on each of Swift, Forced, Spray, Soft, Continuous Argon and Pulsed Argon modes, press the corresponding button, until its LED indicator is on.
2. Power value of the current mode is displayed in Monopolar Coag. power display. Press the power set buttons to change the value. Power value will change one unit by each time you press on the buttons. To speed up power value change, keep your finger on the button.

## Method of Using Monopolar

1. Connect the desired plate to the plate receptacle (on the front panel).
2. Connect the desired surgical instruments to the Monopolar receptacle (on the front panel).
3. If footswitches is used, connect footswitch to Monopolar footswitch receptacle (on the back panel).
4. If modes along with argon are used, then setup APS1 and connect it to Iconic.

### WARNING

For use of Argon gas advantage, use APS1 Argon gas supplier device in order to connect to Iconic device. For information regarding principle of working with Argon gas, its benefits and advantages, installation and launching of APS1, and connection to Iconic please refer to APS1 device User Manual.

5. Settings of can be done in setting section. (please refer to the previous two sections).
6. Perform Monopolar setting in the related section (see the previous section).
7. Place the surgical instrument on the tissue.
8. Press yellow hand switch or footswitch for Monopolar Cut activation and blue hand switch or footswitch for Monopolar Coag. activation. By Monopolar activation, LED indicator of Monopolar generator activation (related to the Monopolar Cut or Monopolar Coag.) will be on and continuous speaker sound is heard. To proceed with cut or coagulation keep the generator active.
9. Stop generator activation after the desired cutting or coagulation by removing the pressure on hand switch or footswitch.

# Chapter 5

## Bipolar Technique

- Information Regarding Bipolar in Receptacles Module Section
- Bipolar Receptacle and its Accessories
- Footswitch
- Information Regarding Bipolar in Mode and Power Setting Section
- Bipolar Modes
- Power Level Changes in Bipolar
- Output Power Selection in Bipolar
- Method of Bipolar Setting
- Method of Using Bipolar

### Information Regarding Bipolar in Receptacles Module Section

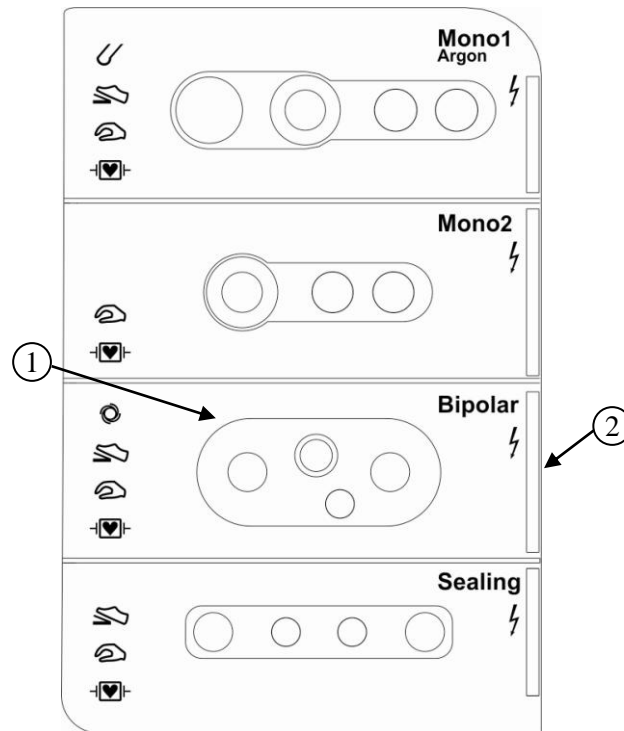

- ① Bipolar instruments receptacle
- ② Indicator of Bipolar generator activation and receiving output via corresponding connector

### Bipolar Receptacle and its Accessories

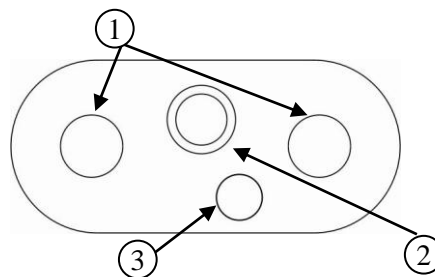

- ① 4 mm normal connectors with 30 mm distance from each other
- ② 2 mm coaxial connector
- ③ 2.5 mm connector

The high frequency main current path is from 4 mm normal connectors and 2 mm coaxial connector. 2.5 mm connector is used for hand switch connections.





## Bipolar Instruments

### WARNING

Kavandish System Company recommends only using Bipolar instruments within the device package which are approved by its quality control department or from the following companies: Bowa, Fiab, Martin, Tecno and Metko.

In the Iconic device, there is the possibility of using various Bipolar instruments having a variety of connectors. Specifications of those connectors are presented in below table.

**Table 2 Types of Bipolar Connectors**

Instrument connector	Activation type	Iconic Bipolar connector
2-pin connector 	Footswitch	4 mm normal connectors
Twin connector 	Footswitch	4 mm normal connectors
3-pin connector (American company type) 	Footswitch and hand switch	4 mm normal connectors and 2.5 mm connector
Connector with 2mm coaxial plug (Martin type) 	Footswitch	2 mm coaxial connector

## Bipolar Coag. Forceps

There are a variety of Bipolar forceps with various shapes and sizes which can be used for tissue coagulation.





In Bipolar forceps, except the two ends of forceps, the rest of areas are covered with insulating material. Thus, coagulation doesn't occur in other areas except the forceps tips when contacting with the tissue. Also it will not cause surgeon's hand irritation when Bipolar output is activated.

**Notice**

Do not tightly press forceps or open its tips, because it will damage the coating of forceps insulation

**Bipolar Cut Scissors**

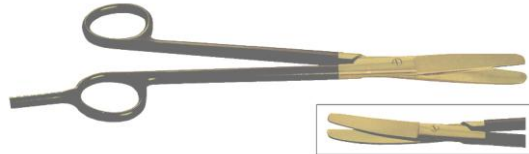

In addition to scissors, some other instruments are used for Bipolar Cut. Those instruments are used in special surgeries. An example of such instruments is shown in the following figure. In this instrument, one of the polar is a thin needle-shape electrode, which is suitable for tissue cut and the other polar is a metal cover to provide the returning current path.

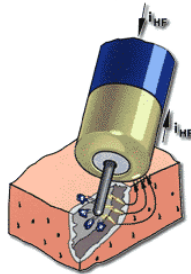

**Information Regarding Bipolar in Mode and Power Setting Section**

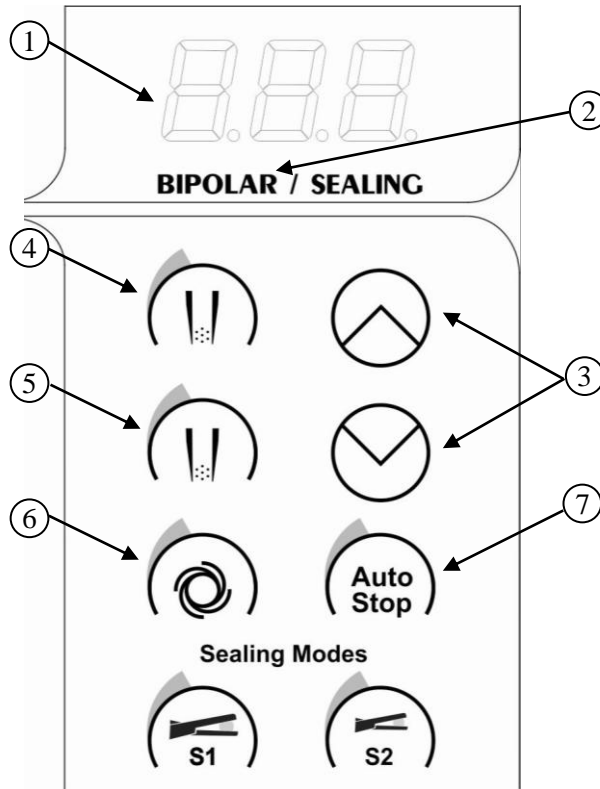

- ① Display of Bipolar/Sealing output power
- ② Indicator of Bipolar activation
- ③ Bipolar/Sealing output power setting buttons
- ④ Button and indicator of Bipolar Cut mode selection
- ⑤ Button and indicator of Bipolar Coag. mode selection
- ⑥ Button and indicator of the condition of Auto Start
- ⑦ Button and indicator of the condition of Auto Stop

Output power will change in certain step by each press on output power setting buttons or keeping a finger on them.

## Bipolar Modes

**Bipolar Cut:** This mode is used for tissue cutting by special designed instruments for bipolar cutting. Also, this mode is used for bipolar cutting in normal saline (bipolar TUR). The power of bipolar cut mode can be rise to 300 watts. Often in bipolar TUR surgery, the power is used is more than 100 watts.

**Bipolar Coag.:** Bipolar Coag. mode provides soft tissue coagulation without carbonization and tissue adhesive effect to electrode. In Iconic, the possibility of selecting of Auto Start and Auto Stop are provided for this technique.

**Auto Start:** In this mode the possibility of automatically activating generator in Bipolar Coag. has been provided. If Auto Start is activated, generator will automatically be activated with a certain delay after sensing the tissue (contacting two tips of forceps with tissue). The delay value can be set from 0 to 2.5 seconds with 0.1 second intervals. Delay setting can be done by LCD display by four-key keypad under LCD. To learn how to set delay in Auto Start of Bipolar Coag. mode please refer to page 56.

It should be mentioned that if the corresponding hand switch or footswitch are pressed; Bipolar Coag. will immediately be out of Auto Start mode.

**Auto Stop:** In this mode, automatic detection of optimal tissue coagulation is provided. In surgery, interval time between optimal coagulation and start of tissue carbonization is about few tenths of a second which makes the coagulation process control difficult by the surgeon. In case Auto Stop is activated, the generator is automatically deactivated when achieving the optimum coagulation, therefore more accuracy and ease in process is achieved.

## Power Level Changes in Bipolar

In Iconic, Bipolar adjustable power level is divided into different ranges. Step of power level changes in various ranges is different:

- Range 1: from 0 to 1 with step 0.1
- Range 2: from 1 to 5 with step 0.2
- Range 3: from 5 to 10 with step 0.5
- Range 4: from 10 to 20 with step 1
- Range 5: from 20 to 100 with step 2
- Range 6: from 100 to 200 with step 5
- Range 7: from 200 to 300 with step 10

## Output Power Selection in Bipolar

The following considerations are recommended for selecting the suitable power;

- In Bipolar Coag., selecting excessive output power causes sticking of electrode to tissue, carbonizing of electrode surface, and preventing from current flow. If the tip of the forceps is clean and power is selected optimally, then complete coagulation is done within 1 to 5 seconds.
- In Bipolar Coag., if the power is selected less than the required value, coagulation is done very slowly.
- In Bipolar Coag., if the selected power is high, the tissue temperature rises rapidly which may lead to increased vapor pressure within the tissue and thus bursting and tearing the tissue.

## Method of Bipolar Setting

1. For setting Bipolar Cut and Bipolar Coag. techniques, press the corresponding button until the related LED indicator is on.
2. For selecting Auto Start and Auto Stop Bipolar Coag. conditions; press the corresponding buttons until its LED indicator is on.
3. If you need to set Auto Start delay value, use LCD display and four-key keypad located below LCD (To learn how to set delay in Auto Start please refer to page 56).



4. Power value of the current mode is displayed in Bipolar/Sealing power display. Press the power set buttons to change the value. Power value will change one unit by each time you press on the buttons. To speed up power value change, keep your finger on the button.

## Method of Using Bipolar

1. Connect the desired surgical instrument to the Bipolar receptacle (on the front panel).
2. If footswitch is used, connect the footswitch to the specific Bipolar/Sealing footswitch receptacle (on the back panel).
3. Perform Bipolar setting in the related section (see the previous section).
4. Place the surgical instrument on the tissue.
5. To activate Bipolar (if one of its mode is selected), press the hand switch or footswitch (in case Auto Start has been selected, Bipolar Coag. will automatically be activated). By Bipolar activation, LED indicator of Bipolar generator activation will be on and continuous speaker sound is heard. To proceed with cut or coagulation keep the generator active.
6. Stop generator activation after the desired cutting or coagulation by removing the pressure on hand switch or footswitch (if Auto Stop has been selected, the generator will automatically detect the tissue coagulation and Bipolar Coag. is disabled. In this condition, the visual and auditory Coag Complete information signal is generated to notify the user (please refer to section information conditions on page 66).

## Footswitch

To use footswitch in Bipolar technique, it is essential to connect a footswitch to Bipolar/Sealing footswitch receptacle on the back panel. If a single pedal footswitch is connected, by pressing the footswitch, the current mode of Bipolar or Sealing is activated. If a two-pedal footswitch is connected, Bipolar cut is activated by pressing the yellow pedal and Bipolar Coag. or Sealing is activated by pressing the blue pedal (according to the choice on front panel).

Note: Generally, Bipolar Cut is activated by yellow pedal and the Bipolar Coag is activated by Blue pedal without any changes in initial power. However, if Bipolar Cut power is greater than 200W, Bipolar Coag is activated by blue pedal, but its power is limited to 200W, and when the blue pedal is disconnected, the Bipolar Cut power is displayed again on the power display.

The footswitch provided with the device is as follows:





**WARNING**

Kavandish System Company recommends only using footswitch within the device package which are approved by its quality control department.

# Chapter 6

## Sealing Technique (Iconic IS410S Models)

- Sealing Technique Features
- Sealing Technique Advantages
- Information Regarding Sealing in Receptacles Module Section
- Sealing Receptacle and its Accessories
- Footswitch
- Information Regarding Sealing in Mode and Power Setting Section
- Sealing Modes
- Power level Changes in Sealing
- Output Power Selection in Sealing
- Regrasp
- Method of Sealing Setting
- Method of Using Sealing

## Sealing Technique Features

In conventional surgical techniques, vessels with a maximum diameter of 2 mm can be coagulated by using conventional Monopolar or Bipolar instrument and for larger vessels, conventional vascular surgery such as tying or clips can be used. Now by using different modes of Seal, coagulability of all vessels with a diameter of less than 7 mm has been provided.

In this technique, vessels or tissues containing vessels place in the two jaws of a special surgical instrument and based on an intelligent algorithm electric current is applied to the tissue following. Applying determined energy along with mechanical pressure by surgical instrument causes melting elastin and collagen in the vessel wall consequently merging the vessel walls. Therefore, without the need of surgical instruments such as stitches or clips; a natural Sealing will occur in the vessels. In this technique the device automatically detect the optimum sealing point and then stops energy application and informs the surgeon about the seal process completion by using visual and auditory signals (please see page 66).

In conventional surgical techniques, vessels with a maximum diameter of 2 mm can be coagulated using conventional Monopolar or Bipolar methods and for larger vessels, conventional vascular surgery such as tying or clips can be used. Now using different modes of seal, the capability of coagulating all vessels with diameter of up to 7 mm has been provided.

## Sealing Technique Advantages

- Capability of coagulation of all vessels with diameter up to 7 mm diameter
- Significant reduction in surgery time and increase of surgeon speed especially where access to blood vessels is difficult.
- Reduction in general bleeding rate of patient during surgery
- Increase of sealed vessel strength against blood pressure increase in comparison with conventional Bipolar and ultrasound methods.
- Surgeon's comfort in using this technique
- Capability of using this technique in open and laparoscopic surgeries
- Optimum coagulation point detection therefore minimum amount of carbonization, tissue sticking and thermal damage.
- Reducing damages due to suture needles and thus reducing the risk of transmitting hepatitis and HIV
- No use of foreign substances in the body and thus, not producing complication caused by leaving foreign substances in the patient body (postoperative complications such as effects of future diagnostic radiology or unwanted infections)

## Information Regarding Sealing in Receptacles Module Section

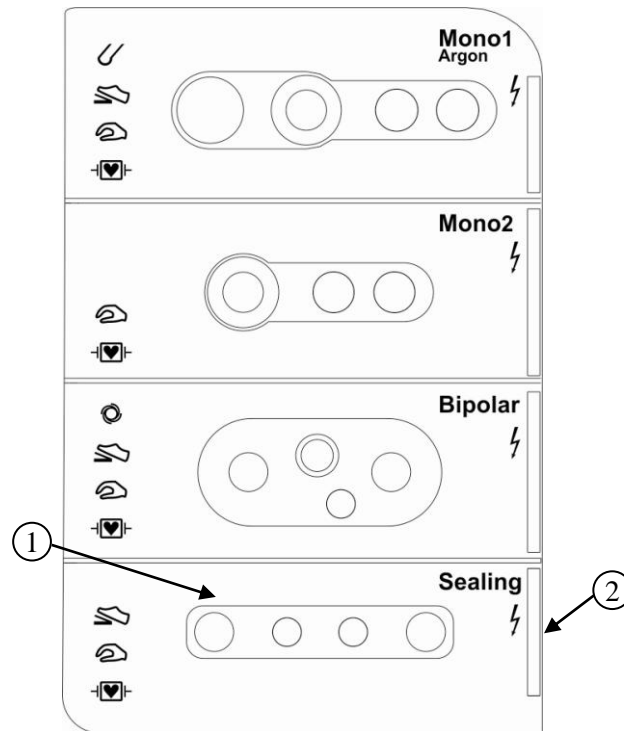

- ① Sealing instruments receptacle
- ② Indicator of Sealing generator activation and receiving output via the corresponding connector.

## Sealing Receptacle and its Accessories

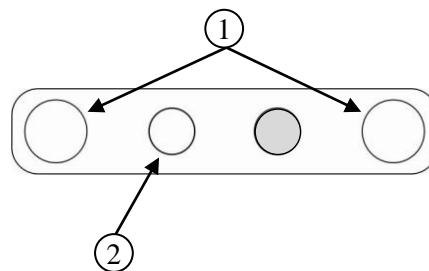







- ① 4 mm normal connectors
- ② 2.5 mm connector







The high frequency main current path is from 4 mm connectors. 2.5 mm connector is used for hand switch connections.

## Sealing Instruments



Iconic is just compatible with certain types of Sealing surgical instruments in Table 3.

**Table 3 Compatible Sealing Accessories with Iconic family devices**

Instrument type	Mode	Activation type	Surgery type	Some of surgical applications	
LS1037 	SealI	Footswitch and hand switch	laparoscopy	Adhesiolysis- Appendectomy Colectomy- Gastric Bypass Nissen fundoplication Lap- Assisted vaginal hysterectomy Adrenalectomy- gastrectomy Splenectomy- slapingo Oophorectomy- Nephrectomy	
LS1020 	SealI	Footswitch and hand switch	open	Adhesiolysis Abdominal hysterectomy Gastric Bypass Colon Resection Colectomy Radical prostatectomy Gastrectomy splenectomy Nephrectomy Slapingo - Oophorectomy	
LS2110 , LS2111 	SealI	Footswitch	open		
LS3090 , S3092 	SealI	Footswitch and hand switch	open		
LS3110 , LS3112 	SealI	Footswitch and hand switch	open		
Bowa – Tissueseal 	SealI	Footswitch	open		
LF4318 , LF4418 	SealI	Footswitch and hand switch	open		Urology Colorectal General surgery Gynecology

Instrument type	Mode	Activation type	Surgery type	Some of surgical applications
LF1623 , LF1723 , LF1823, LF1923 	Seal2	Footswitch and hand switch	open	Abdominal hysterectomy Gastric bypass Colon resection Cystectomy Radical prostatectomy Gastrectomy Salpingo-oophorectomy
LF1637 , LF 1737 , LF1837 , LF1937 	Seal2	Footswitch and hand switch	laparoscopy	Adhesiolysis , Adrenalectomy Colectomy , Gastrectomy Gastric bypass Laparoscopic hysterectomy Nephrectomy Nissen fundoplication Oophorectomy Splenectomy
LF1644 , LF1744 , LF1844 , LF1944 	Seal2	Footswitch and hand switch	laparoscopy	Adhesiolysis , Colectomy Laparoscopic hysterectomy Nephrectomy Oophorectomy Roux-en-Y gastric bypass Sleeve gastrectomy Splenectomy
LS1200 	Seal2	Footswitch	open	Throidectomy Tonsillectomy Neck Dissection Parotidectomy Other general surgery procedures
BZ4212 , BZ4212A 	Seal2	Footswitch and hand switch	open	Tonsillectomy Throidectomy Neck Dissection Parotidectomy
LS1500 	Seal2	Footswitch and hand switch	laparoscopy	Adhesiolysis- colectomy Gastric bypass Nissen fundoplication Adrenalectomy- gastrectomy Splenectomy Slapingo- Oophorectomy Nephrectomy



Instrument type	Mode	Activation type	Surgery type	Some of surgical applications
Bowa Ligator 	Seal2	Footswitch and hand switch	laparoscopy	Adhesiolysis- colectomy Nissen fundoplication Adrenalectomy- gastrectomy Splenectomy Slapingo- Oophorectomy Nephrectomy
LS1520, LF1520 	Seal2	Footswitch and hand switch	open	Cystectomy Nephrectomy Prostatectomy Open colectomy Axillary dissection Hemorrhoidectomy Liver resection Gynecological procedures
LF1212, 1212A, LF2019 	Seal2	Footswitch and hand switch	open	Ear, Nose and Throat (ENT) General Plastic/Reconstructive Urologic Thoracic

In terms of activation, Sealing instruments are of two types. Some instruments have hand switch which can be activated both by hand switch and footswitch. Some other ones don't have hand switch and can be only activated by footswitch. Connector of instrument with hand switch has 3 pins and connects to 4 mm connectors and 2.5 mm connector of Sealing receptacle. Connector of instrument that can be activated only with footswitch has 2 pins and connects to 4 mm connectors

#### WARNING

In Sealing technique, if a surgical instrument which is not listed in the above table is used, there will not be enough reliability for seal quality.

## Footswitch

To use footswitch in Sealing technique, it is essential to connect a single-pedal footswitch to Bipolar/Sealing footswitch receptacle on the back panel. If a single pedal footswitch is connected, by pressing the footswitch the current mode of Bipolar or Sealing is activated. If a two-pedal footswitch is connected, Bipolar cut is activated by pressing the yellow pedal and Bipolar Coag. or Sealing is activated by pressing the blue pedal (according to the choice on front panel).

The footswitch provided with the device is as follows:





**Information Regarding Sealing in Mode and Power Setting Section**

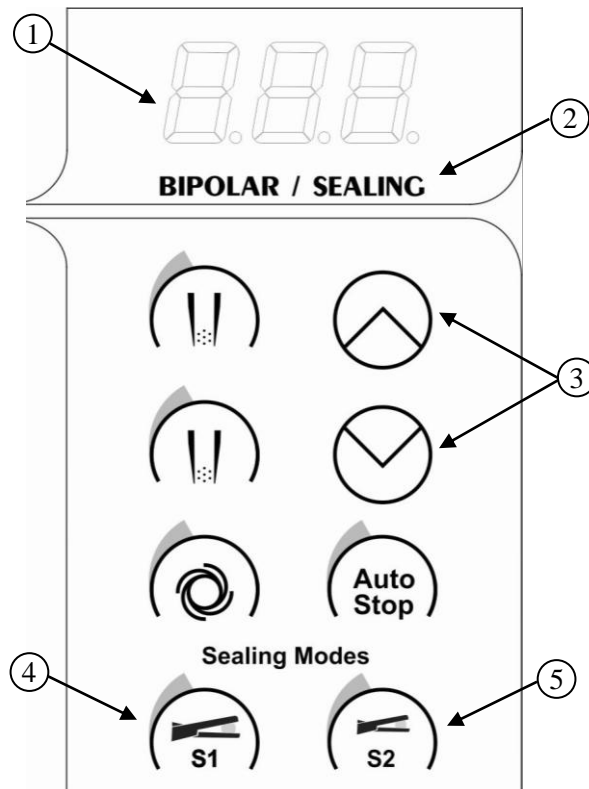

- ① Display of Bipolar output power
- ② Indicator of Sealing activation
- ③ Bipolar output power setting buttons
- ④ Button and indicator of Seal1 mode selection
- ⑤ Button and indicator of Seal2 mode selection

Output power will change in certain step by each press on output power setting buttons or keeping a finger on them.

## Sealing Modes

In Iconic, Sealing technique is suitable for coagulating all vessels with a diameter up to 7 mm. This technique has two modes of seal1 and seal2. For each Sealing surgical instrument compatible with the device, one of those two modes is appropriate. For more information, see Table 3 Compatible Sealing Accessories with Iconic family devices.

**Seal1:** This mode is designed for a variety of surgical instruments which have more contact surface with the tissue and more energy is required that vessels be completely sealed.

**Seal2:** This mode is designed for a variety of surgical instruments which have less contact surface with the tissue and less energy is required that vessels be completely sealed.

## Output Power Selection in Sealing

Vessel Sealing mode operates smartly. It means this mode applies sufficient power to tissue for sealing based on tissue impedance assessment. Therefore, power adjustment is not required in seal1 and seal2.

## Regrasp

When the generator successfully completes the Sealing process, the informative signal of Seal Complete will be generated. But if for any reason the generator could not succeed the seal, Regrasp alarm is generated. The causes of Regrasp conditions and solutions of fixing the problem are provided in Table 4.

**Table 4 Information and alarm conditions in sealing modes**

Regrasp situation	Possible cause	Solution
Regrasp ----- Energy Stopped	Seal activity demand was stopped.	For seal modes, after activating device, don't stop applying energy until device displays "Seal Complete" message.
Regrasp ----- Low Current 0	Low current at the start of sealing.	Check the connections. There is a possibility of disconnection in connectors or cables and possibility of accessory breakdown. Also, if the tissue is not in the handpiece's jaws, this alarm is displayed.
Regrasp ----- Low Current 1	Low current in energy applying phase during seal process.	Check the connections. There is a possibility of disconnection of connectors or cables and possibility of accessory breakdown.
Regrasp ----- Low Current 2	Low current in impedance control phase during seal process.	Check the connections. There is a possibility of disconnection in connectors or cables and possibility of accessory breakdown.
Regrasp ----- High Current 1	No tissue response to electrical current during Seal process. Despite high current flow, desired response is not observed in tissue. There is a possibility of instrument failure or short circuit between the two jaws of surgical instrument.	Without cutting the tissue, open the jaws and grasp the tissue again. If the error repeats, replace the surgical instrument.



Regrasp ----- High Current 2	Detecting short circuit in impedance control phase during Seal activity. Despite high current flow, desired response is not observed in tissue. There is a possibility of instrument failure or short circuit between the two jaws of surgical instrument.	Without cutting the tissue, open the jaws and grasp the tissue again. If the error repeats, replace the surgical instrument.
Regrasp ----- Time Over	No complete tissue response observed at the specified time. Maybe the tissue taken by surgical instruments is too thick. Maybe there is accumulation of blood and fluids around the jaws of surgical instruments.	Without cutting the tissue, open the jaws, drain blood and fluids around the jaws and grasp the tissue again.
Regrasp ----- High Power	Unallowable output power. Possibility of device failure.	Stop using the device. To check and fix the problem, send the device to the manufacturer.
Regrasp ----- Unexpected Change	Unexpected response in tissue. Much change is observed in the electrical impedance of the tissue.	Without cutting the tissue, open the jaws and grasp the tissue again.
Seal complete	Successful Seal process completion	The signal is just informative and no action is needed.

## Method of Sealing Setting

For setting Sealing technique on each of Seal1 or Seal2 modes, just press the corresponding button until its LED indicator is on. This mode should be selected based on used surgical instrument (see Table 3 Compatible Sealing Accessories with Iconic family devices on page 45).

## Method of Using Sealing

1. Connect the desired surgical instrument to Sealing receptacle (on the front panel)
2. If footswitch is used, connect footswitch to the specific Bipolar/ Sealing footswitch receptacle (on the back panel).
3. Set the Sealing in the relevant setting section (See the previous section).
4. Grab the tissue with surgical instrument and press the instrument handle until you assured the instrument is locked. The sound of instrument locking can be heard while pressing.

### WARNING

By locking surgical instrument, the suitable mechanical pressure for Sealing is provided. If the instrument is not locked while applying energy, there would not be enough reliability for Sealing quality

5. To activate the Sealing and apply of energy to tissue (if one of its mode has been selected), press on instrument hand switch or corresponding footswitch. By Sealing activation, LED indicator of Sealing generator activation is on and continuous sound of speaker is heard. Keep the device active until the end of Sealing process. To proceed with cut or coagulation keep the generator active. The device detects the completion of Sealing process automatically; visual and auditory Seal Complete information signal is generated to notify the user (refer to information conditions section on page 66) and device activation stops.
6. If Regrasp alarm is generated (See alarm conditions section on page 61), Sealing process is not complete. Therefore activate the Sealing again and apply energy to tissue. If Regrasp condition is repeated, refer to Table 4 on page 50. After checking the cause, follow the appropriate solution.

**WARNING**

If you remove the pressure on hand switch or footswitch before Seal Complete announcement. Seal process is not complete and device generates Regrasp alarm. In this condition, there is not enough reliability for Sealing quality and Sealing process should be repeated.

# Chapter 7

## LCD Display Pages and How to Use them

- LCD Display Applications
- Settings Pages
- Programming Pages
- Display Page of Alarm Codes which are Generated while Working with the Device

## LCD Display Applications

LCD display is used for two purposes in Iconic device:

- Some LCD pages are only demonstrative and just provide information about device status and its performance to the user. For example:

In case the generator is not activated, LCD displays the system main program in the first row which is one of the four main General Surgery, Micro Surgery, TUR or Argon Endo programs. In the second row, the selected mode of Monopolar Cut is displayed which is one of Pure, Blend1, Blend2, Blend3, ArPure, ArBlend1, ArBlend2 or ArBlend3 modes. In the third row the selected mode of Monopolar Coag. is displayed which is one of Swift, Forced, Spray, Soft, Continuous Argon (ArCont) or Pulsed Argon (ArPulsed) modes. In the fourth row, alarms (if any) are displayed. An example of the LCD page in generator inactivation mode is shown in below figure.

<p style="text-align: center;">GENERAL SURGERY CUT: Pure COAG: Swift</p>
--

However, In case of generator activation; in the first row, type of output, which is activated, from nine types of Monopolar Cut1, Monopolar Cut2, Monopolar Coag1, Monopolar Coag2, Monopolar Coag (in the state of both Monopolar outputs activation in spray mode), Bipolar Cut, Bipolar Coag, Seal1 and Seal2 techniques are displayed. In the second row, mode is displayed and in the third row the type of accessories which has been used for activation (Hand Switch or Foot Switch) is displayed. An example of such pages is shown in below figure.

<p style="text-align: center;">MONOPOLAR COAG1 Effect: Swift Activation: Foot sw</p>
--

- In addition to the mentioned display options, some of supplementary settings and device programming can be performed only through LCD display and 4-key keypad below the LCD.

In each LCD page, some tools have been included for settings (entering next pages, back to the previous page and option selections). Those tools are shown in the lowest row of LCD and in each page there can be up to four tools. Using application of each of those tools can be done through corresponding buttons of 4-key keypad.

The available tools for setting are as following:

Menu	Entering to main page
Ent.	Confirmation of option and selection of continuous path or continuation of operation on the page
↑	Direction of move upward or number increase or letter change
↓	Direction of move downward or number decrease
Back	Back to previous page selection
Set	Confirming the selection or the performed adjustment
Inc	Increasing the selected option
Dec	decreasing the selected option
Load	Loading the program
Save	Saving the program
Name	Entering to program name page
CHR	Selecting the program blinking letter to change it

## Settings Pages

In settings pages, general mode and delay time in Auto Start can be set.

### How to Enter the Setting Pages

1. First, press the menu button to enter the main menu (main page).

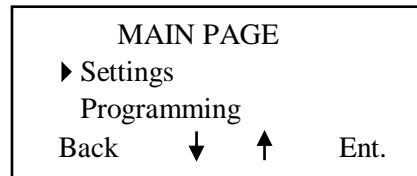

2. Select "Settings" using ↓ and ↑ tools in the main page.
3. Then enter the corresponding page by pressing Ent. button.

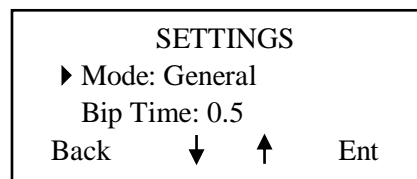

### How to Select Micro Surgery, General Surgery, TUR and Argon Endo Modes

In settings section there are four general options of Micro Surgery, General Surgery, TUR and Argon Endo modes that can be selected.

To select any of above mode, follow the below instruction:

1. First enter to the settings page.
2. Select "Mode" option by ↓ and ↑ tools in the setting page
3. Press Ent. button. General modes selection space is displayed.

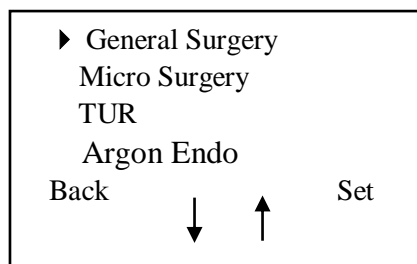

4. Select the desired general mode using ↓ and ↑ tools.
5. Then press Set button to confirm the selection. In this case LCD display the below message for a few moments. Meaning the selected option is confirmed.

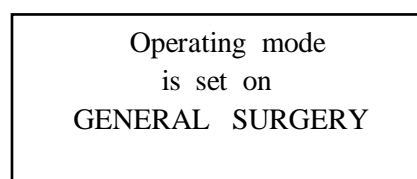

Then again, settings page will be displayed.

**General Surgery:** This mode is selected when normal modes are desired in all techniques. In normal



condition, this mode should be always selected.

**Micro Surgery:** When delicate surgery with low powers and high accuracy is desired, this mode is used. The maximum user-configurable power is limited in this mode.

**TUR:** This mode is for operation in liquid environments. This mode can be selected only by pressing TUR mode button on the front panel.

**Argon Endo** (specially for Endoscopy): Due to the fact that generally less power is suitable for endoscopy, the maximum user-configurable power is limited in this mode.

To use Argon Endo mode in endoscopy, the following steps are required:

1. Set the device in Argon Endo mode by LCD menus.
2. Connect the argon probe to the Mono1 output connector.
3. Connect the polypectomy or papillotomy snare to the Mono2 output connector.
4. To cut the tissue, put the snare in the endoscope and activate the Mono2 output by pedal in one of the cutting modes. Snare will begin to cut the tissue.

Note: to avoid perforation and Zipper phenomena in cutting (uncontrolled cutting), it is recommended to use the Blend modes with the minimum required power firstly, and secondly, complete the cutting by periodic and terminated press of yellow pedal for a short time (each time about a second or a piece of a second). Complete the cut in several steps.

5. To coagulate with argon, remove the snare from the endoscope and insert the argon probe into the endoscope. In Pulsed Argon mode, activate the Mono1 with the blue pedal and perform apc.

Note: In Argon Endo mode, if one of the Argon modes (APC, Pulsed APC, and Argon Cut) is selected, Mono1 is activated by pedal, but in other modes such as Pure, Blend, or Forced and ... the Mono2 output is activated by pedal. In devices with no Argon Endo mode, the pedal always activates Mono1 output.

Note: To self-adjust the proper setting for endoscopy including Argon Endo and Pulsed Argon by turning on the device, these settings can be saved on program number 30. If this setting is done at the factory, the device will be in Argon Endo mode and Pulsed Argon mode when turned on.

Note: There is no Micro Surgery mode on devices with Argon Endo mode.

### How to Set Delay Time in Auto Start of Bipolar Coag. Mode

1. First enter to the settings page.
2. Select "Bip. time" using ↓ and ↑ tools.

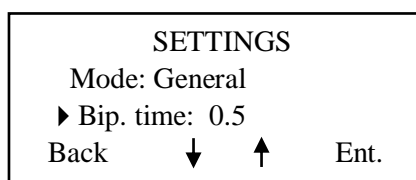

3. Press Ent. button to enter the delay setting space.

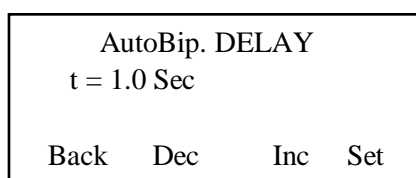

4. Set the delay time on the desired value using Inc and Dec tools.



5. Press Set button to confirm setting. In this case LCD displays the below message for a few moments. Meaning the selected option is confirmed.

AutoBip. DELAY  
time is set to  
1.0 sec

Then again, settings page will be displayed.

### Programming Pages

In Iconic, the possibility of storing 30 programs, including various modes and powers setting for different surgeries, is provided. Those predetermined settings provide the possibility of rapid changes in different surgeries. 10 settings for different surgeries have already saved by the company. The list of those settings, related surgeries, operation modes, and powers are given in table below.

**Table 5 Saved procedure programs**

Program No.	30	1	2	3	4	5	6	7	8	9	10
<b>Procedures</b>	Default Program	Monopolar TUR	Bipolar TUR	Cardiothoracic (Sternum)	ENT (T&A) Needle	GI (Polypectomy)	Laparoscopy	Mastectomy	Neurosurgery (Spine)	APC - ablation or High hemostasis in open surgery	APC - Endo, medium hemostasis for GI-Bleeding
<b>Program Name</b>	DPROG	MNTUR	BITUR	CTHST	ENTNE	GIPOL	LAPAX	MSTCT	SPINE	APCOS	APCGI
<b>Monopolar Cut</b>	<b>Blend2</b>	60	100	60	60	30	30	30	30	30	30
<b>Monopolar Coag</b>	<b>Swift</b>	50	50	50	50	50	50	50	50	50	50
	<b>Forced</b>	40	50	50	40	30	30	30	30	30	30
	<b>Spray</b>	40	40	30	60	20	10	15	60	20	20
	<b>Soft</b>	80	100	80	80	80	80	80	80	80	80
	<b>Continuous Argon</b>	40	30	30	30	30	30	30	30	30	60
	<b>Pulsed Argon</b>	20	20	20	20	20	20	20	20	20	40
	<b>Bipolar Cut</b>	70	50	70	30	30	30	30	30	30	30
	<b>Bipolar Coag</b>	30	30	30	30	30	30	30	30	30	30
	<b>Auto Bipolar</b>	20	20	20	20	20	20	20	20	20	20
	<b>Seal</b>	Seal1	Seal1	Seal1	Seal1	Seal2	Seal1	Seal1	Seal1	Seal1	Seal1
	<b>Surgery</b>	General	TUR	TUR	General	General	General	General	General	General	Argon Endo
	<b>Auto Start Time(ms)</b>	500	500	500	500	500	500	500	500	500	500

The surgeon can save their desired program via LCD and 4-key keypad and loading it when it is required.  
 Note: In Iconic IS410 in which there is no seal mode, Bipolar Coag. with 30W power is selected for bipolar technique.

Note: Default program is set on program 11 to 30.

### How to Enter Programming Pages

1. First, press the menu button to enter the main menu (main page).
2. Select “Programming” using ↓ and ↑ tools in the main page.
3. Then pressing Ent. button to enter the corresponding page.

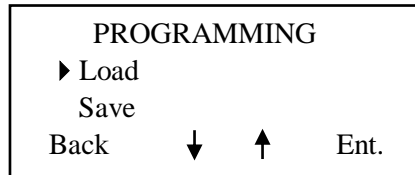

### How to Recall the Preset Program in the Memory

1. First enter to the programming page.
2. Select “Load” option using ↓ and ↑ tools.
3. Press Ent. button to enter the load page.

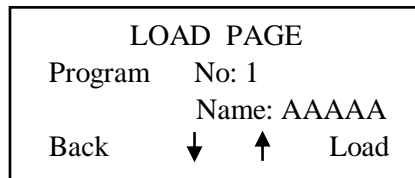

4. Select the desired program number using ↓ and ↑ tools.
5. Press the load button to load information of the selected memory. In this case LCD display following for a few moments as shown on below figure.

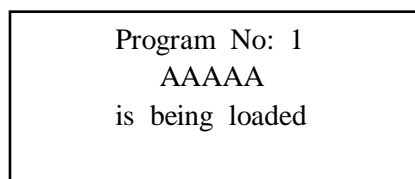

### How to Save a Program

1. First enter to the programming page.
2. Select “Save” option using ↓ and ↑ tools.
3. Press Ent. button to enter save page.

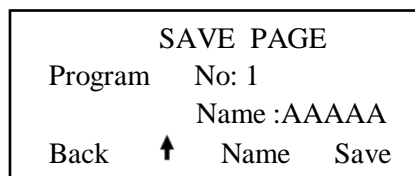

4. Select the desired number (memory number from 1 to 30) using ↑ tool.
5. To name the program, press Name button to enter the program name page. In this case, the first character of program name is blinking.



```

PROGRAM NAME
Program   No: 1
          Name: AAAAA
Back     ↑   CHR   Set

```

6. Select the desired character for blinking part of program name using ↓ and ↑ tools. Each character can be selected from English letters or numbers from 0 to 9.
7. Press CHR button to move to next blinking characters name. By each CHR press, blinking character of name is changing. Then according to the previous paragraph, select the desired character. Continue this process till the name of program is completely selected and entered.
8. Press Set button to confirm the program name. In this case, the LCD displays the following message for a few moments as shown on below figure. Then it will enter to saving page.

```

The Name
AAAAA
is associated to
program No 1

```

9. Set the desired mode and power through available controllers on the front panel.
10. Press Save button to save settings in memory. In this case, LCD displays the following message for a few moments as shown on below figure.

```

System settings
are being saved
into program No. 1
AAAAA

```

## Display Page of Alarm Codes which are Generated while Working with the Device

In case some alarms generated while working with the device, the corresponding alarm code is logged in memory (please refer to alarm code tables on page 64).

### How to Observe the Logged Alarm Codes

1. First, press the menu button to enter the main menu (main page).
2. Select “Errors” term in the main page using ↓ and ↑ tools.
3. Press Ent. button to enter the errors page. The generated alarm codes while working with the device are displayed in this page.

```

ERRORS
22, 12

Back

```

#### Notice

In errors section, only alarm codes which are generated while working with the device are shown and errors related to self checking are not shown here.

# Chapter 8

## Alarm System

- Alarm Conditions
- Alarm Signals
- Alarm Logging System in the Memory
- Information Conditions
- Information Signals Characteristics



## Alarm Conditions

Device alarm conditions with relevant specifications are provided in the following table.

Table 6 Alarm Conditions

Event	Message on the LCD	Group	Priority	Impact on the activity	Log (in memory)
Failure in patient plate condition during Monopolar activation and or request	<b>Fail: Plate</b>	Technical/Functional	Medium	Deny the permission or stop of Monopolar activity	✓*
Failure in patient plate condition while no request for Monopolar activation	<b>Er: PT</b>	Technical/Functional	Low	--	✓*
Voltage increase in internal power supply more than the determined value	<b>Fail: OV</b>	Technical	Medium	Stop of activity	✓
Decrease in output power of HF generator below the permitted value	<b>Er: FE</b>	Technical	Low	--	✓
Increase of leakage current in Monopolar activation more than the permitted value	<b>Fail: LC</b>	Technical	Medium	Stop of activity	✓
Continuous operation of the equipment for 30 seconds	<b>Fail: Time Out</b>	Functional	Medium	Stop of activity	×
Continuous operation of the equipment for more than 10 seconds	<b>Er: TO</b>	Functional	Low	--	×
Regrasp**(in Iconic IS410S models)	<b>Fail: Regrasp</b>	Functional	Medium	Stop of activity	×
Activation request during normal start of the system, when it was in Standby or Self-Checking mode, or Setting Bipolar to Auto Start Coagulation when the electrode is on tissue	<b>Er: IR</b>	Technical/Functional	Low	Deny the permission of activity of the generator that caused the alarm	×
System memory failure	<b>Er: ME</b>	Technical	Low	--	✓
Disconnection between system internal boards during the request for system activation	<b>Fail: Connector</b>	Technical	Medium	Deny the permission or stop of activity	✓
Disconnection between system internal boards when no activation request presents	<b>Er: CN</b>	Technical	Low	--	✓
Increase in output power of generator more than a permitted value, during activation	<b>Fail: Extra Power</b>	Technical	Medium	Stop of activity	✓

Event	Message on the LCD	Group	Priority	Impact on the activity	Log (in memory)
Using the device more than 30s continuously in the power greater than 100 Watt. Due to uncommon use, device has stopped. Let the device to cool down for about 1 minute.	<b>Heat Factor 1</b>	Functional	Medium	Deny the permission or stop of Monopolar activity	×
Using the device continuously in monopolar mode with high current. Possibility of temperature increase in plate place. Deactivate the device and let the plate place to cool down.	<b>Heat Factor 2</b>	Functional	Low	--	×
Using the device continuously in monopolar mode with high current. Possibility of temperature increase in plate place. Due to the unusual device use, the device is deactivated. Let the plate place to cool down.	<b>Heat Factor 3</b>	Functional	Medium	Deny the permission or stop of Monopolar activity	×

\*Only in circuit failure of patient plate monitoring, this alarm is recorded in memory.

\*\*See Table 4 Information and alarm conditions in sealing modes on page 50.

### Failure in Patient Plate Condition Alarm

This alarm is generated in two conditions:

- **Plate connection failure:** This failure is occurred due to disconnection of plate connector or its cable in single plate and for dual plate is due to disconnection of plate connector or its return cable, poor quality of plate connection to the patient's body, full disconnection of plate to patient's body or large variations in resistance between the two parts of plate. Naturally, resistance variation is not checked in Monopolar activation due to possible effects of generator noise on plate circuits.
- **Circuit failure of patient plate monitoring:** This failure means that there is error in transmission circuit of dual plate connection condition to the control system. In case of such failure, the relevant alarm code is recorded in the memory. This error is only investigated when the generator is inactive phase. But subsequent to this alarm, in case of a request for activation of Monopolar technique, the equipment will not be activated and "Fail: plate" alarm is generated.

### System Memory Failure Alarm

By each time writing system settings in memory, the validation of the stored values in the memory with those settings are checked, and their inequality causes "system memory failure" alarm. By any demand for system operation, "system memory failure" alarm condition ends.

### Alarm Conditions Group

Based on the external cause of event and its occurrence part, alarm conditions are divided into two groups.

- **Technical**  
The event occurs in the equipment or its accessories.
- **Functional**  
The event happened in the interaction between equipment and operator/patient while using the equipment



An alarm may occur due to various technical or functional reasons. In Table 6 Alarm Conditions (see page 61) in front of those alarm conditions in group section, technical/ functional term has been mentioned.

### Alarm Conditions Priority

Two priorities have been assigned to alarm conditions based on the amount of harm that can have for the patient, operator or the equipment. Those two priorities are called “medium” and “low” based on the IEC60601-1-8 standard.

- **Medium priority**

At the time of alarm conditions with medium priority, due to possibility of serious injury, generator activity is stopped and the equipment cannot meet the user expectation. This issue itself could have potential hazard. Thus, quick response of user is needed to fix the problem.

- **Low priority**

At the time of alarm conditions with this priority, possible damages are so mild that does not require urgent need to change the equipment operation status (such as generator inactivation). But, the user should be aware of such a condition so proper response is provided to the relevant alarm condition in appropriate time. Also, in this case that the equipment is in continuous operation, less auditory noise (due to less urgency of low priority) is generated.

## Alarm Signals

By detecting of alarm conditions, visual and auditory signals (through LCD, LED, 7-segment and Buzzer) are generated in the system. All means of generating those signals are activated (by turning on the equipment). So the user can be confident of alarm system functionality. In order to perceive the visual and auditory signals by user (except LCD), maximum of 3 m distance between user and equipment is recommended. The maximum distance of 1.5 m is suitable for LCD checking.

### Alarm Signals Characteristics with Medium Priority

By occurrence of an alarm with medium priority, a term associated with alarm condition which starts with “Fail.” word is displayed on the LCD. Also, ERROR LED or plate LED (based on the alarm) starts to flash in red color and auditory signal is generated according to a certain pattern by a buzzer with 79 dBA sound level (from 1m distance) and 2300 Hz frequency.

- **LEDs flashing pattern**

Continuously flashes on (600 ms) and off (250 ms).

- **Auditory signal generation pattern**

Three subsequent sounds, which is generally called burst is repeated every 4s. In each burst, buzzer is turned on and off every 250 ms.

If the medium priority alarm condition no longer exists, all generated alarm signals will cease. Only if the burst of auditory signal is not yet completed, the signal will be continued until the end of the burst.

### Alarm Signals Characteristics with Low Priority

By occurrence of an alarm with low priority, a term associated with alarm condition which starts with “Er.” word is displayed on the LCD. Also, ERROR LED or plate LED (based on the alarm) is on in red color and auditory signal is generated according to a certain pattern by a buzzer with 79 dBA sound level (from 1m distance) and 2300 Hz frequency.

- **LEDs flashing pattern**

They turn on continuously

- **Auditory signal generation pattern**

Buzzer turns on and off twice continuously with 150 ms intervals.

If the low priority alarm condition no longer exists, all alarm signals will cease.



### Regrasp Alarm Signals Characteristics (Iconic IS410S Models)

By occurrence of this alarm, in addition to usual signals (ERROR LED, buzzer, message on LCD), Bipolar/Sealing 7-segments will also flash with 0.83 Hz approximate frequency and 50% duty cycle (600 ms (on), 600 ms (off)). By demand removal the last buzzer burst is completed and its sound is discontinued, but the other signals continue. If Regrasp alarm has been created with demand removal, buzzer will only ring for one burst.

Regrasp alarm continues until the request for Sealing is repeated. Of course, with each activation request or detecting of each alarm or information condition, all alarm signals except 7-segments flashing are discontinued. This means exist of alarm mode. In another word, ending all visual and auditory signals except 7-segments means Regrasp alarm is finished. Also by selecting each Bipolar modes, 7-segments LED flashing is interrupted and by re-selection of one of Sealing modes, they start to flash again.

### Alarm Signals Generation Ranking

With occurrence of alarm conditions with medium and low priority simultaneously, alarm signals is generated only for alarm with medium priority. Meanwhile, with occurrence of alarm with the same priority, all relevant terms are displayed on the LCD.

### Alarm Logging System in the Memory

Among all alarms, only technical alarms that indicate equipment failure are stored in memory as code; so, in case it is needed, system problems can be determined. The memory has the capacity to store 10 alarms, meaning that always the information of the last 10 alarms is stored in the memory. The content of this memory does not disappear by equipment turning on/off or power disconnection.

The code associated with each alarm is consisted of two characters. The right character is related to alarm condition type and the left character is related to the mode that in which this alarm has occurred. Characters related to alarm condition type and mode types that alarm has occurred (during their operation) are given in the following tables.

Alarm condition type	Right character of the code
Voltage increase in internal power supply more than the specified value	1
Decrease in output power of HF generator less than the permitted value	2
Increase of leakage current in Monopolar activation more than the permitted value	3
Problem in patient plate condition due to Circuit failure of patient plate monitoring	4
Increase in output power of generator more than the permitted value, during activation	5
Disconnection between system internal boards	7
System memory failure	1

Technique	Mode	Left character of the code
Not active	---	0
Monopolar Cut	Pure	1
	Blend1	2
	Blend2	3
	Blend3	4
Monopolar Coag.	Swift	5
	Forced	6
	Spray	7
	Soft	8
	Continuous Argon	9



---

	Pulsed Argon	A
Bipolar Cut	---	B
Bipolar Coag.	Auto Start	C
	Manual	D
Sealing (in Iconic IS410S models)	Seal1	E
	Seal2	F

## Information Conditions

In addition to alarm conditions, other conditions also occur that although they are not harmless to the patient or operator, but they require user attention. Those conditions are called information condition. They include error of equipment use (when it is not harmless to the patient or operator) and new event (such as generator activation) that occurs in normal use of the equipment. The equipment information conditions with the corresponding description are given in table below.

**Table 7 Information conditions**

Events	Message on the LCD	Impact on activity
Generator activation	Custom page	--
Starting with zero power or decrease of power to zero value during activation	<b>P=0</b>	Deny the permission or stop of activity
Simultaneous activation request of Monopolar Cut and Monopolar Coag. Or request for Sealing activation while one of Bipolar modes is selected (in Iconic IS410S models) Or request for Bipolar mode activation while one of Sealing modes is already selected (in Iconic IS410S models)	<b>Unacceptable Request</b>	Deny the permission of activity
Set the Bipolar Coagulation on Auto start when the pen is not on the tissue	<b>Auto Bip.</b>	--
Detecting optimum coagulation of the tissue in Auto Stop mode	<b>Coag Complete</b>	Stop of activity
Detecting optimum Seal in the Sealing mode (in Iconic IS410S models)	<b>Seal Complete</b>	Stop of activity

## Information Signals Characteristics

With detecting of information conditions, visual and auditory signals (through LCD, LED, 7-segment and speaker) are generated by the system.

Information signals corresponding to generator activation are different from other information conditions. The generator has a specified page on LCD which is displayed with its activation. This page includes technical information that is activated. During generator activation, LEDs corresponding to the activated technique are on and auditory signal is generated continuously by a speaker with adjustable sound level (50 dBA to 70 dBA from 1 m distance).

- **The sound frequencies generated during each technique activation**

Monopolar Cut: 680 Hz

Monopolar Coag: 520 Hz

Monopolar Coag1 and Monopolar Coag2 activation simultaneously: 470 Hz

Bipolar Cut: 610 Hz

Bipolar Coag. and Sealing (in Iconic IS410S models): 470 Hz

With occurrence of other information conditions, a term associated with it is displayed on the LCD. In some of those conditions (including P=0 and Unacceptable Request) the corresponding 7-segment also start to flash. Also, auditory signal is generated (according to a certain pattern) by the speaker with adjustable sound level (50 dBA to 70 dBA from 1m distance).

- **7-segment flashing pattern**

7-segments turn on and off with 350 ms interval.

- **Auditory signal generation pattern**

The speaker turns on and off twice consecutively with 350 ms interval.

## Information Signals Rank in Comparison with Alarm Signals

In case of information and alarm conditions simultaneously, usually the message related to alarm condition(s) is displayed on the LCD (But other corresponding information and alarm signals are



generated). However, LCD message related to information conditions corresponding to the user request (including P=0, Unacceptable Request, Coag Complete and Seal Complete) as long as the request is not resolved those messages have priority to those messages related to alarm conditions.

# Chapter 9

## Maintenance and Repair

- Manufacture Responsibility
- Routine Maintenance
- Safety Checks
- Cleaning and Disinfecting
- After Sales Service

## Manufacture Responsibility

Kavandish System Company can only accept the safety and device performance if below instructions are followed;

- The installation and launching of the device is done according to this User Manual.
- Device is used in accordance with the instructions of this User Manual.
- Any modifications or repairs can only be done by authorized service personnel of Kavandish System Company or its authorized representatives.

## Routine Maintenance

It is recommended to check the device calibration and overall safety and performance condition of the system once a year. Therefore we suggest you to send the device to Kavandish System Company or one of its authorized representatives for calibration and safety checks and receive qualitative control results and safety standard test card along with your unit.

## Safety Checks

Safety checks are performed to define whether the device's condition regarding safety and performance is in accordance with defined technical status. These checks include the following:

- Visual inspection
- Impedance between Receptacles
- Bipolar and Monopolar Output RF Leakage (according to IEC 60601-2-2)
- Line Frequency (50-60 Hz) Current Leakage (according to IEC 60601-1)
- Plate and Tissue Sensor Auxiliary Current Test (according to IEC 60601-1)
- Grounded conductor test (according to IEC 60601-1)
- Input current consumption
- Output HF Power measurements

These tests can be performed without removing the sealed enclosure of device. In case test results show any defect or failure in device performance, the device should be immediately returned to Kavandish System Company or one of its authorized representatives for examination and fixing. Do not attempt to open the enclosure or modify the device.

## Cleaning and Disinfecting

Turn off the device and remove the cable from power outlet before any cleaning. Then clean all surfaces of the unit using a moistened cloth and cleanser or mild disinfectant solution.

### WARNING

Use nonflammable material for cleaning and disinfecting. If you are forced to use flammable materials wait a while until those materials are completely evaporated before you turn on the device.

### NOTICE

Penetration of liquids into the device can cause damage to it; since there is the possibility of liquids penetration from its bottom side, observe necessary precautions during cleaning and disinfecting the device.

---

### **Cleaning Accessories**

For cleaning and disinfecting of each accessory, follow the available instructions in related packaging.

### **After Sales Service**

One of the important feature and essential advantages of this device compare to similar ones is its fast and excellent after sales support and services.

This product is warranted for 24 months from delivery date. During this time any defect due to defective parts, workmanship or manufacturer's fault will be resolved free of charge in the company. Also the company guarantees to provide its services in terms of repair, spare part, and support for 10 years.

#### **NOTICE**

Dear customer, in case of any problem and dissatisfaction regarding our product, packaging, delivery, or recycling of the unit (after its life time) or in case of any suggestion that may help us improving our service and product quality, please contact our after sales support department in Kavandish System Company.

# Chapter 10

## Technical Specifications

- Dimensions and Weight
- Input Power
- Operating Parameters
- Transport and Storage Parameters
- Internal Memory
- Displays
- Generator Activation Tone
- Alarm Tone
- Current Consumption
- High Frequency Leakage Current
- Low Frequency Leakage Current
- Patient Plate Monitoring System
- Duty Cycle
- Output Characteristics
- Standards
- Drip Proof (IEC 60601-2-2)
- IEC Classification
- Maximum Output Power Graphs versus Load Resistance
- Output Power Graphs versus Adjusted Power Level
- Maximum Output Voltage Graphs versus Adjusted Power Level



## Dimensions and Weight

Width	40 cm
Depth	44 cm
Height	17 cm
Weight	8.3 kg

## Input Power

Mains voltage	220V $\pm$ 10% , 50HZ (110 V $\pm$ 10% , 50/60HZ)*
Maximum power consumption	800 VA
Fuse	Standard-5*20mm 5 A - 250 V AC (or 10 A)*

\*Depends on customer request

## Operating Parameters

Temperature	+10°C to +40°C
Relative humidity	25% to 85% (non-condensing)
Atmospheric pressure	700 mbars to 1060 mbars

## Transport and Storage Parameters

Temperature	-20°C to +65°C
Relative humidity	10% to 90% (non-condensing)
Atmospheric pressure	500 mbars to 1060 mbars

## Internal Memory

Storage capacity	2048 b
------------------	--------

## Displays

LCD	LCD display has 4 lines of 20 characters for setting modes and memories and displaying alarms and messages
7-Segment	9, 7-Segment, for displaying output powers
LED	8 LED for displaying generator activation in different techniques 1 for displaying plate alarms 1 for displaying alarm existence

## Generator Activation Tone

Volume (adjustable)	50 dBA to 70 dBA (from 1 m distance)
Frequency	<ul style="list-style-type: none"> <li>• Monopolar Cut: 680 Hz</li> <li>• Monopolar Coag.: 520 Hz</li> <li>• Mono Coag1 and Mono Coag2 (simultaneously): 470 Hz</li> <li>• Bipolar Cut: 610 Hz</li> <li>• Bipolar Coag.: 470 Hz</li> <li>• Sealing: 470 Hz (in Iconic IS410S models)</li> </ul>
Duration	Continuous during generator activation

**Alarm Tone**

Volume (non-adjustable)	79 dBA (from 1 m distance)
Frequency	2300 Hz
Duration	<ul style="list-style-type: none"> <li>• Alarm with medium priority: one burst includes 3 consecutive tones with 250 ms intervals repeated every 4 s</li> <li>• Alarm with low priority: 2 consecutive tone with 150 ms intervals</li> </ul>

**Current Consumption**

Without R.F. power	120 mA (or 220 mA)*
With maximum R.F. Power	4.5 A(rms) (or 8 A(rms))*

\*Depends on delivered system

**High Frequency Leakage Current**

Monopolar	Less than 150 mA
Bipolar	Less than 20 mA
Sealing (in Iconic IS410S)	Less than 20 mA

**Low Frequency Leakage Current**

Normal condition*	Less than 10 $\mu$ A
Single fault condition*	Less than 50 $\mu$ A

\* If all patient terminals are tied together

**Patient Plate Monitoring System**

Measurement frequency	100 kHz $\pm$ 10 kHz
Acceptable resistance ranges	
Single plate	Less than 25 Ohms
Dual plate	25 Ohms to 150 Ohms
Alarm occurs	- If the measured resistance is outside the acceptance range In case of dual plate connection, if the measured resistance at any time increases more than 50 percent relative to the minimum measured resistance

**Duty Cycle**

Duty Cycle of the device, while the maximum output power in the nominal load (or a load with the resistance of less than nominal load), is utilized, has been established based on (10 s/30 s) active and inactive cycle. It means that after every 10 second operation of the unit generator, the generator should get switch off and remain 30 second in that position. In case that output power is less than maximum rate (or a load with the electric resistance of more than nominal load is utilized); it may be possible to increase the duty cycle of the unit.

## Output Characteristics\*

### Monopolar Cut

Mode	Maximum output voltage (V <sub>P-P</sub> )	Maximum output current (A)	Heating Factor (A <sup>2</sup> s)	Crest Factor**	Maximum output power (Watts)	Rated load (Ohms)
Pure	1420	1.2	44.1	1.5	360	350
Blend1	2725	1.1	33.6	2	330	450
Blend2	3325	1.1	35.9	2.5	300	500
Blend3	3700	1.1	34.9	2.8	270	500

### Monopolar Coag.

Mode	Maximum output voltage (V <sub>P-P</sub> )	Maximum output current (A)	Heating Factor (A <sup>2</sup> s)	Crest Factor**	Maximum output power (Watts)	Rated load (Ohms)
Swift	3600	1.0	27.7	3.3	200	500
Forced	3650	0.8	20.9	4.5	140	500
Spray	5250	0.8	19.1	5.5 to 7.5***	120	500
Soft	660	1.1	34.3	1.5	100	200
Continuous Argon	8100	0.8	17.7	7 to 9***	100	500
Pulsed Argon	10200	0.7	14.5	10 to 16***	50	500

### Bipolar

Mode	Maximum output voltage (V <sub>P-P</sub> )	Maximum output current (A)	Crest Factor**	Maximum output power (Watts)	Rated load (Ohms)
Bipolar Cut	1400	4.1	2.5	300	100
Bipolar Coag.	370	2.2	1.5	200	50
Auto Start Bipolar Coag.	360	1.8	1.5	50	50

### Sealing (Iconic IS410S Models)

Mode	Maximum output voltage (V <sub>P-P</sub> )	Maximum output current (A)	Crest Factor**	Maximum output power (Watts)	Rated load (Ohms)
Seal1	375	4.2	1.5	250	25
Seal2	375	4.0	1.5	250	25

\*Nominal Frequency is 410kHz±1kHz.

\*\*Crest Factor is a measurement of waveform which increases by increasing waveform coagulation capabilities and is calculated from the following equation:

$$C.F = V_{peak} / V_{rms}$$

\*\*\*According to power adjustment

## Standards

Iconic device meets all relevant clauses of IEC 60601-1, IEC 60601-1-2 and IEC 60601-2-2 standards.

### Drip Proof (IEC 60601-2-2)

Iconic enclosure is constructed so that in case of liquid spillage in normal use, the safety and performance does not adversely affect.

### IEC Classification

Protection class	I
Type of output	CF (Cardiac Floating)
Type of patient circuit	Floating Output

### Maximum Output Power Graphs versus Load Resistance

In these graphs, power level is constant and load value varies. The graphs have been drawn for the two cases of maximum power and half of maximum power in each mode.

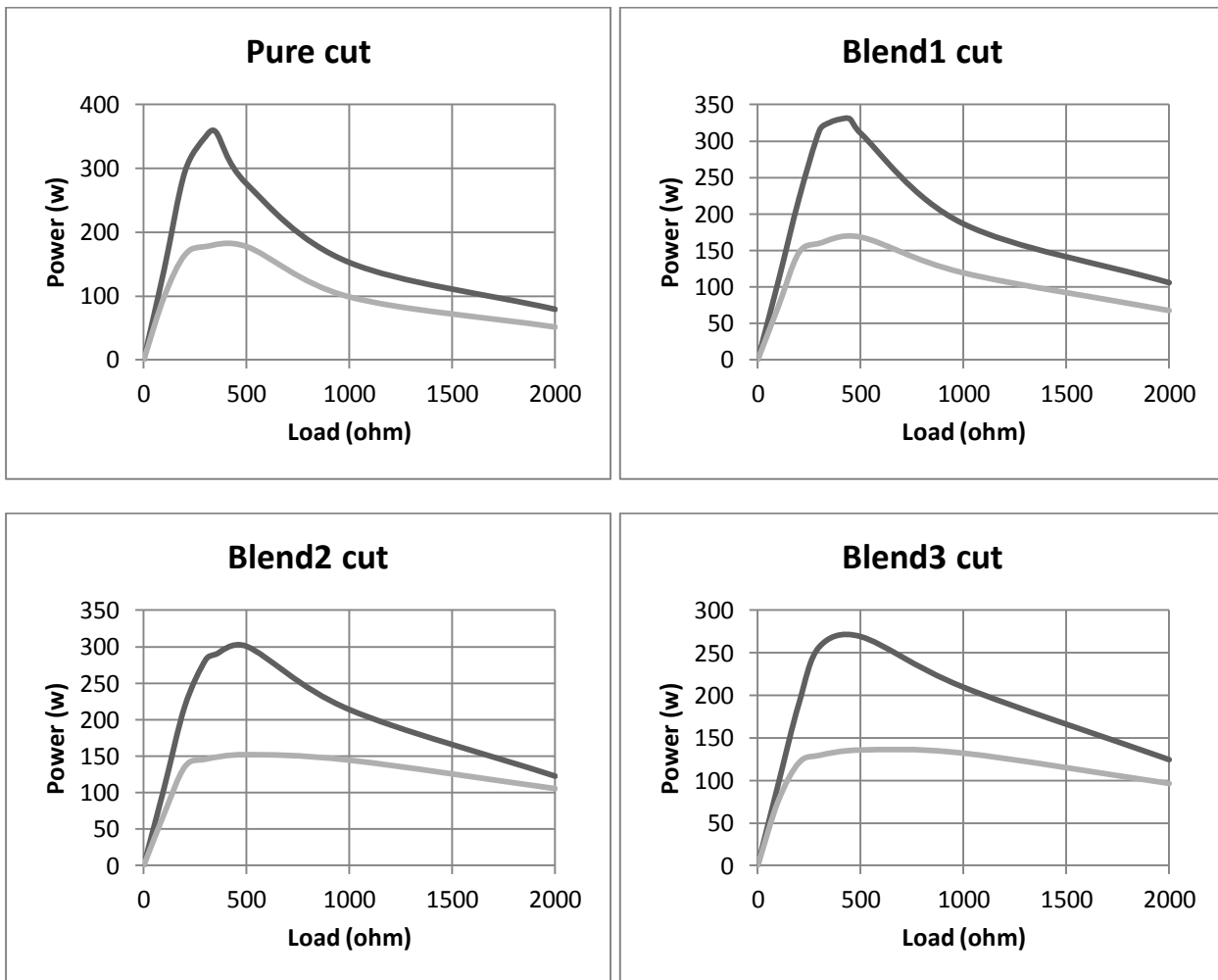

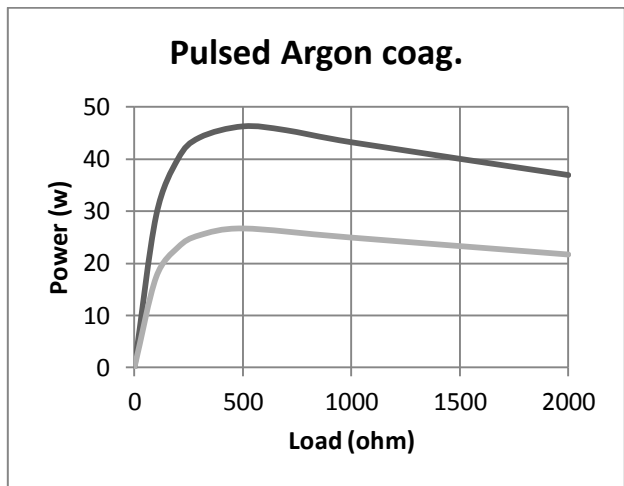
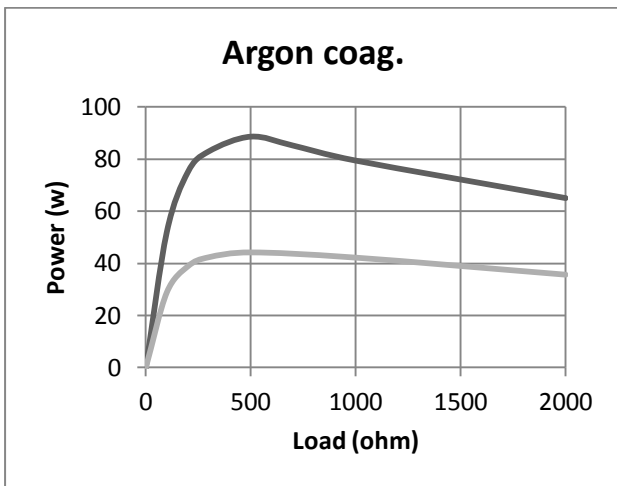
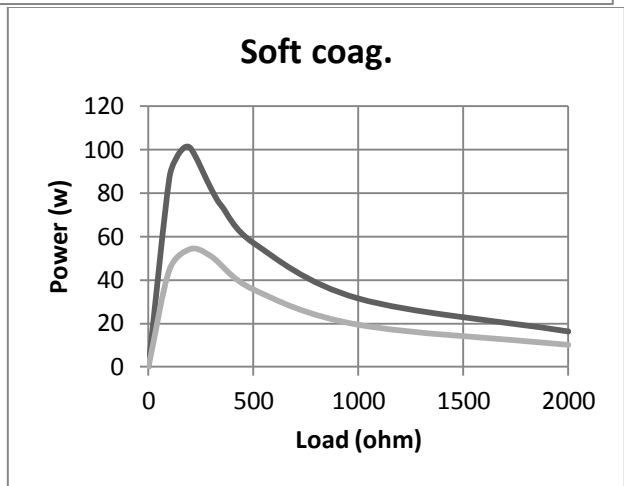
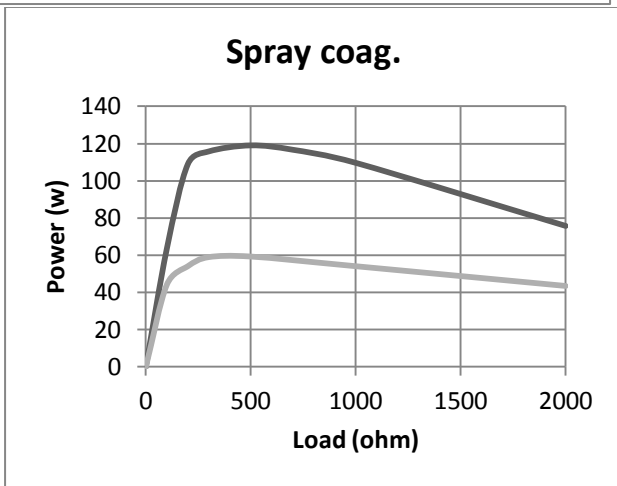
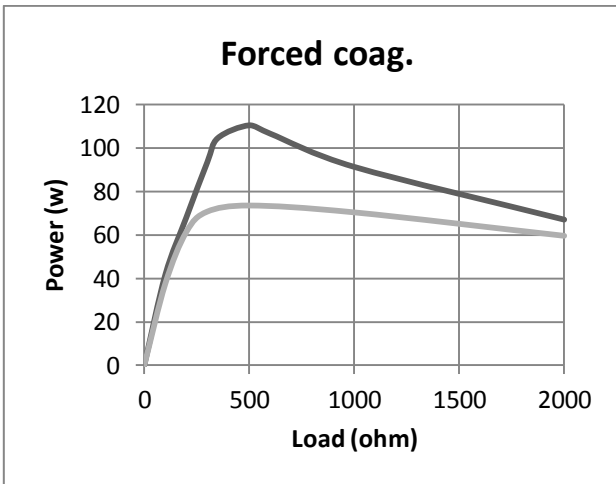
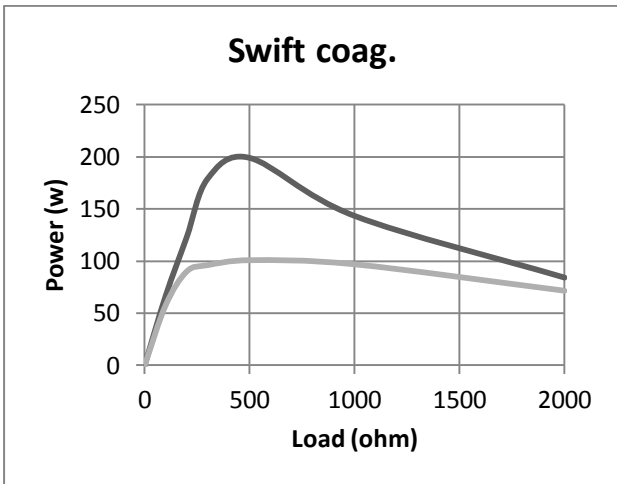

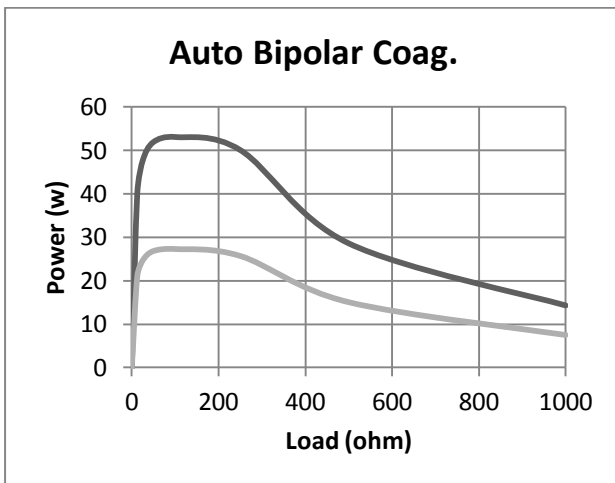
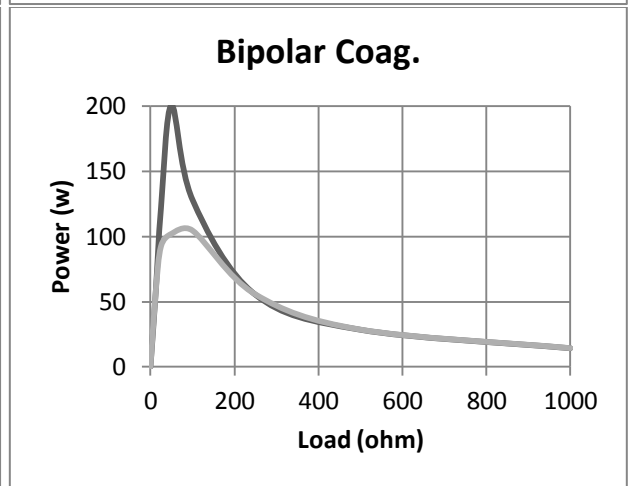
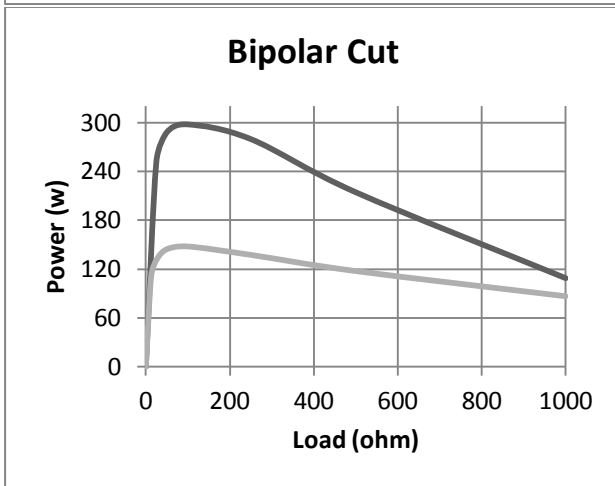
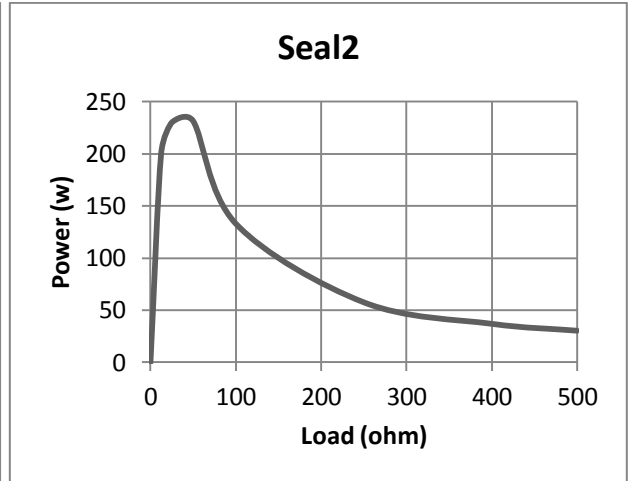
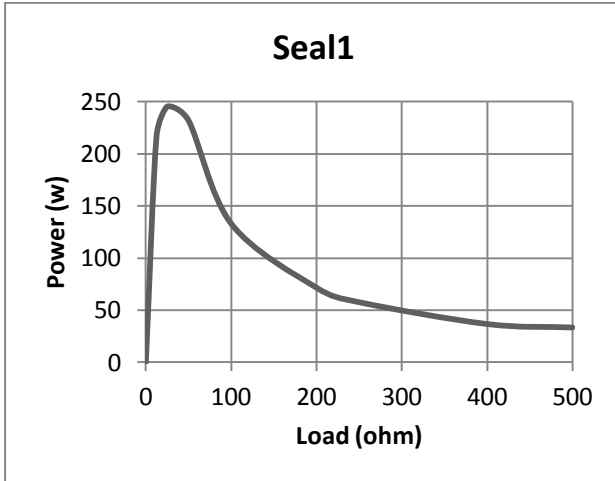

### Output Power Graphs versus Adjusted Power Level

In these graphs, load is constant and power level varies from minimum to maximum.

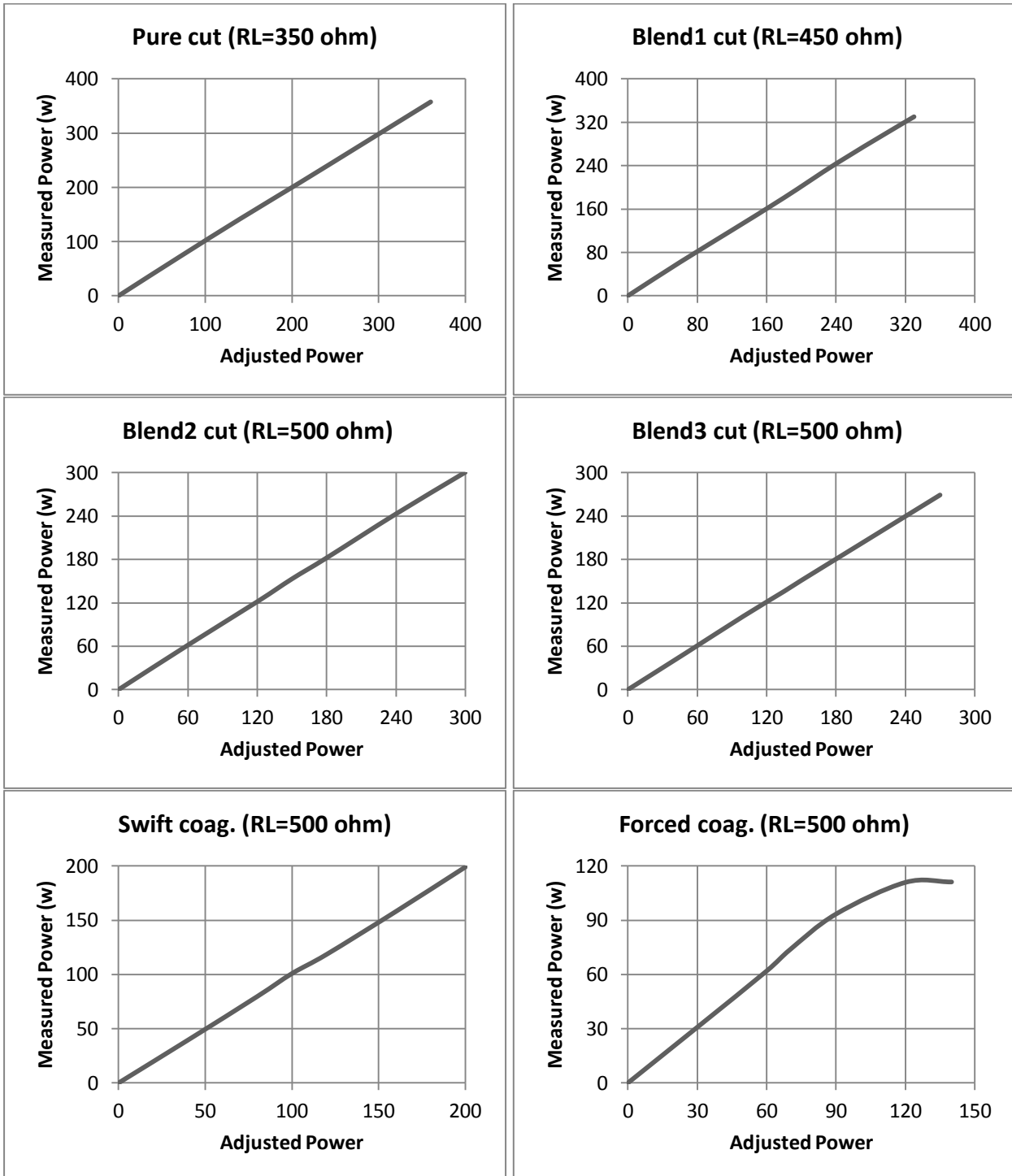

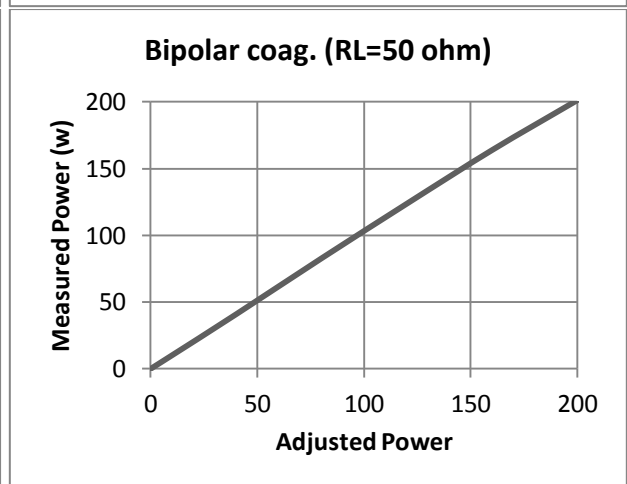
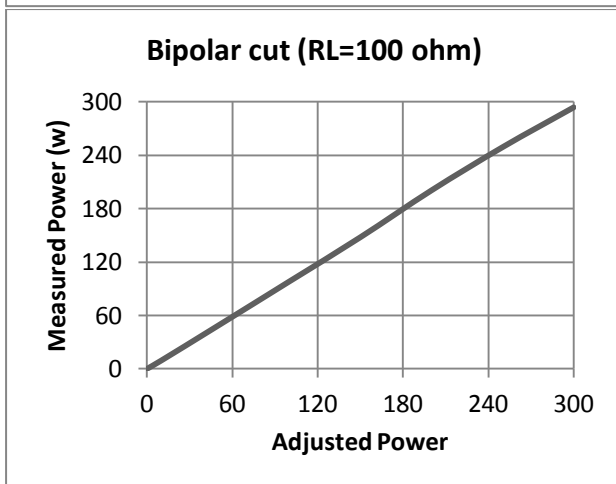
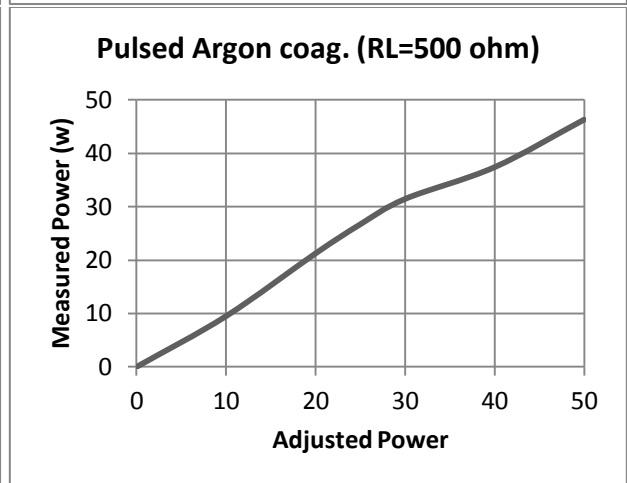
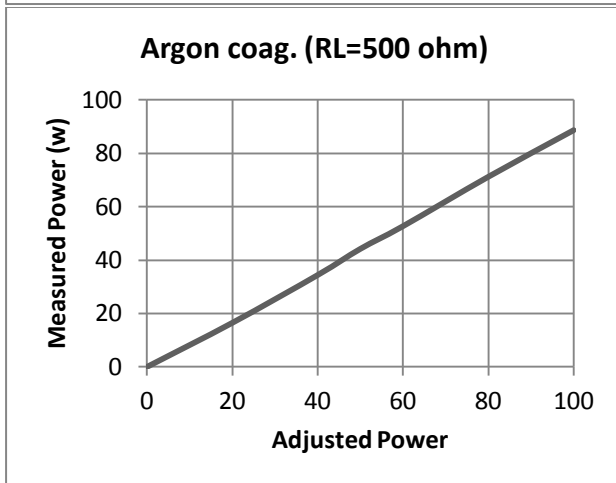
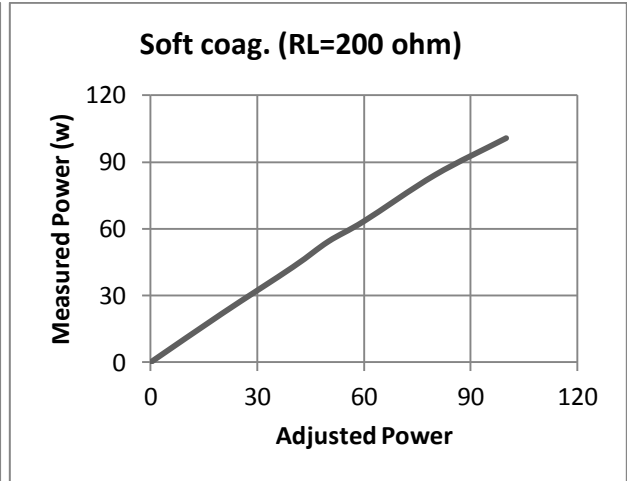
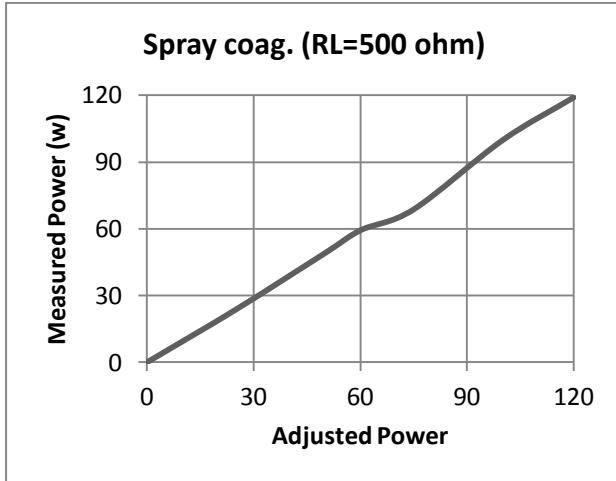



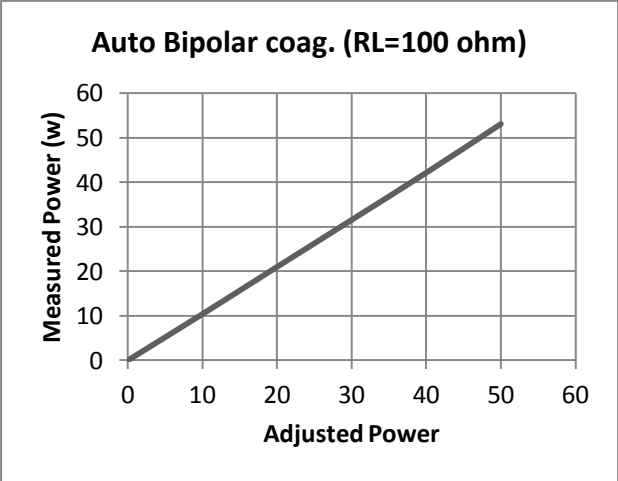

## Maximum Output Voltage Graphs versus Adjusted Power Level

In these graphs, output voltages are measured in open circuit condition in different power levels.

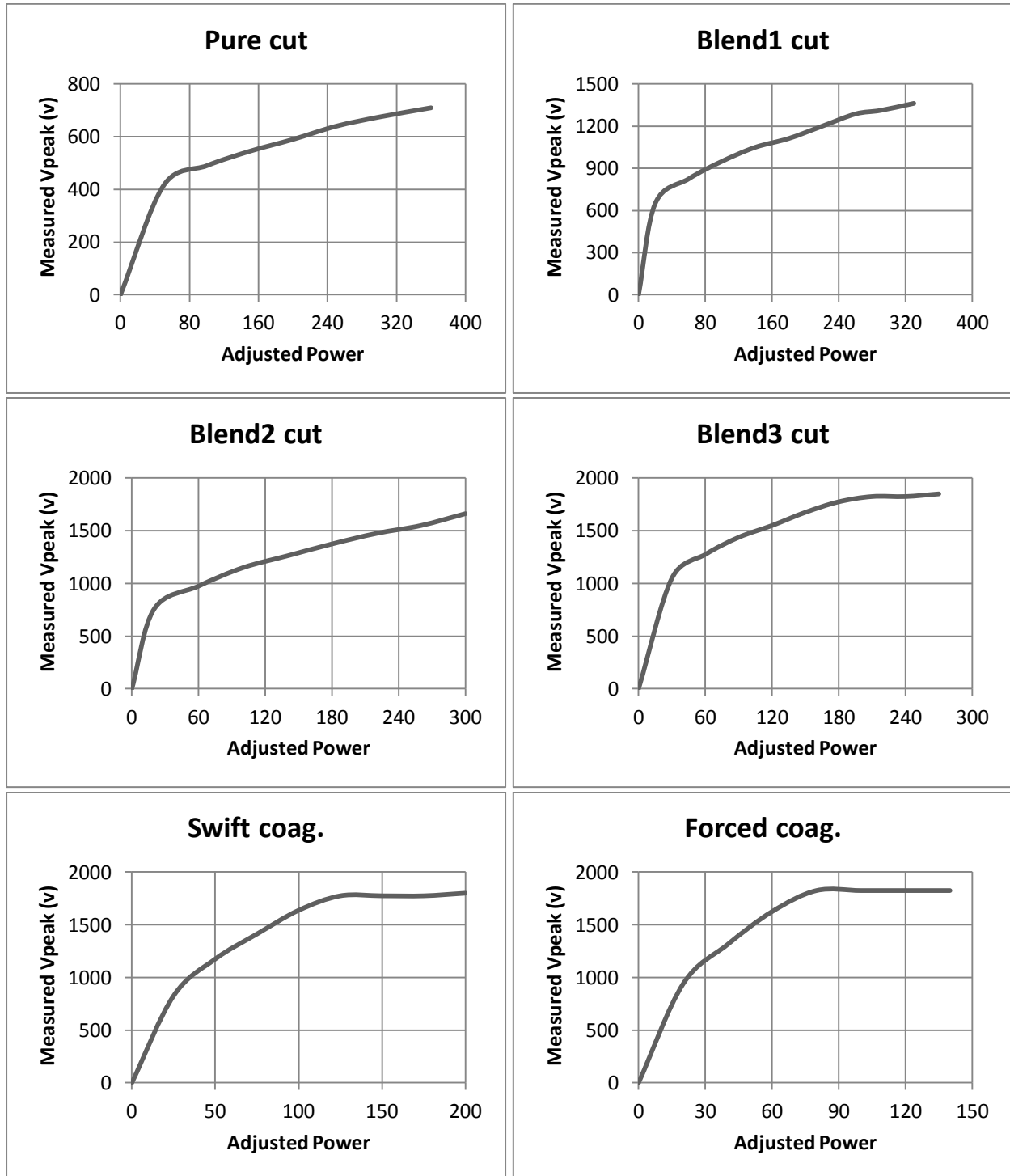

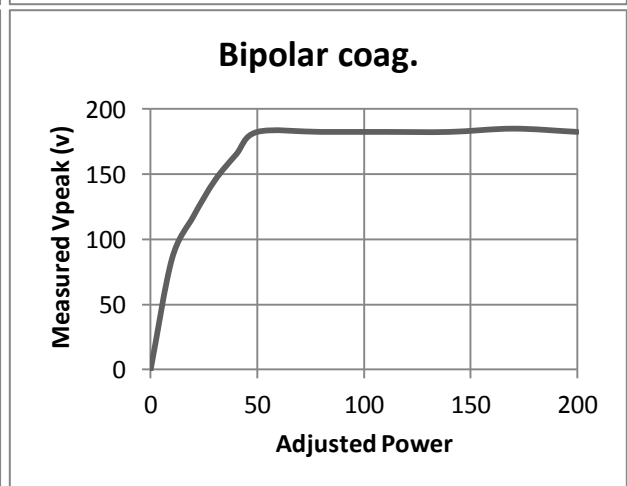
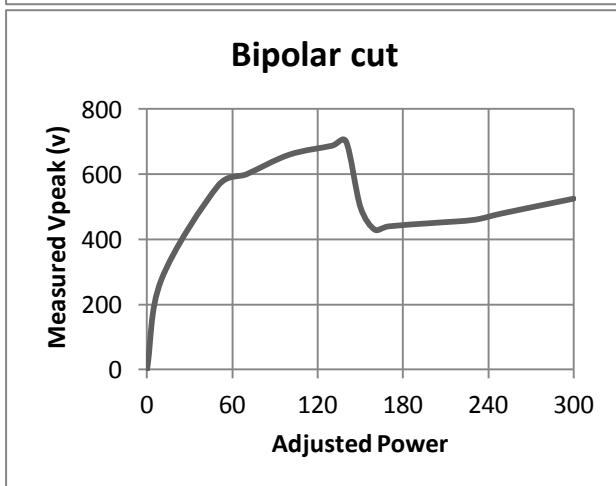
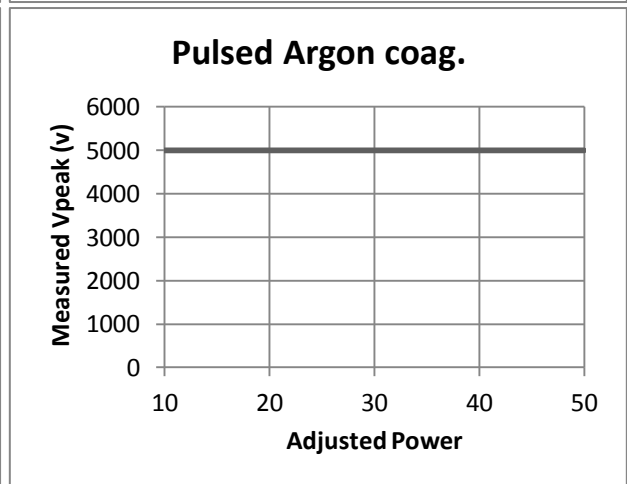
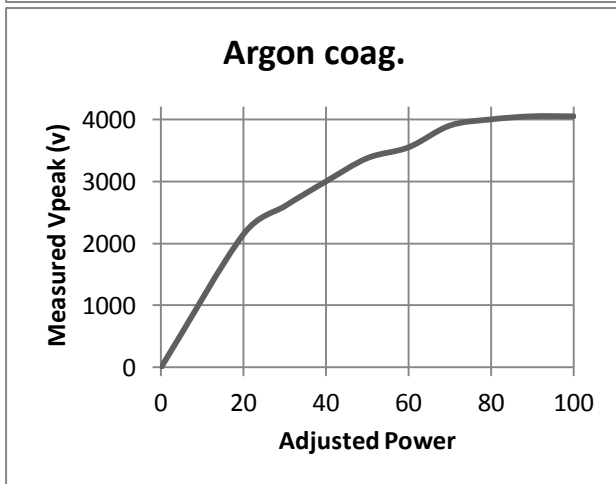
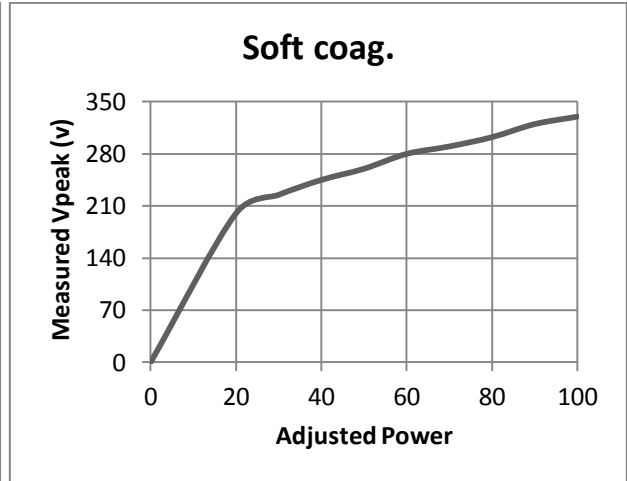
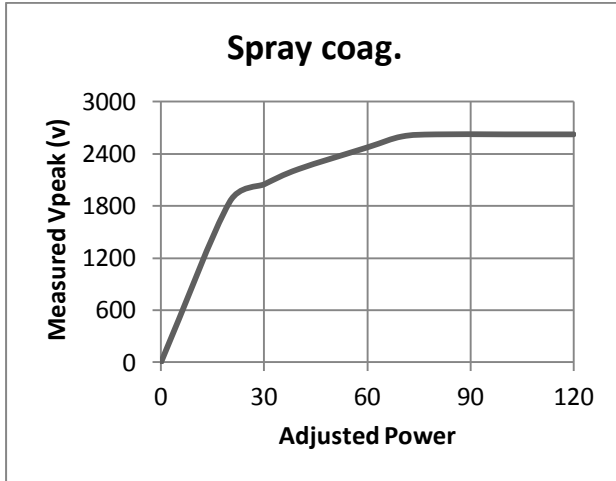

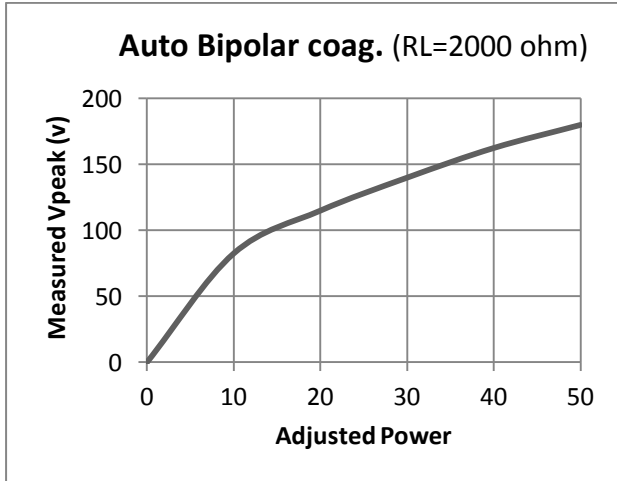

# **Chapter 11**

## **EMC Compliance**



<b>Guidance and manufacturer's declaration - electromagnetic emissions</b>		
The Iconic is intended for use in the electromagnetic environment specified below. The customer or the user of the Iconic should assure that it is used in such an environment.		
<b>Emissions test</b>	<b>Compliance</b>	<b>Electromagnetic environment - guidance</b>
RF emissions CISPR 11	Group 2	The Iconic, when the output switch is activated must emit electromagnetic energy in order to perform its intended function. Nearby electronic equipment may be affected.
RF emissions CISPR 11	Group 1	The Iconic, when the output switch is not activated uses RF energy only for its internal function. Therefore, its RF emissions are very low and are not likely to cause any interference in nearby electronic equipment.
RF emissions CISPR 11 (2009)	Class A	The electrosurgical equipment is suitable for use in all establishments, other than domestic establishments and those directly connected to the public low-voltage power supply network that supplies buildings used for domestic purposes.
Harmonic emissions IEC 61000-3-2 (2005+A1+A2)	Class A	
Voltage fluctuations/flicker emissions IEC 61000-3-3 (2013)	complies	

<b>Guidance and manufacturer's declaration - electromagnetic immunity</b>			
The Iconic is intended for use in the electromagnetic environment specified below. The customer or the user of the Iconic should assure that it is used in such an environment.			
<b>Immunity test</b>	<b>IEC 60601 test level</b>	<b>Compliance level</b>	<b>Electromagnetic environment guidance</b>
Electrostatic discharge (ESD) IEC 61000-4-2 (2008)	±8 kV contact ±15 kV air	±8 kV contact ±15 kV air	Floors should be wood, concrete or ceramic tile. If floors are covered with synthetic material, the relative humidity should be at least 30
Electrical fast transient/burst IEC 61000-4-4 (2012)	±2 kV for power supply lines ±1 kV for input/output lines	±2 kV for power supply lines ±1 kV for input/output lines	Mains power quality should be that of a typical commercial or hospital environment.
Surge IEC 61000-4-5 (2006)	±0.5 kV AC Power input port ±1 kV differential mode ±2 kV line to ground.	±0.5 kV AC Power input port ±1 kV differential mode ±2 kV line to ground.	Mains power quality should be that of a typical commercial or hospital environment.
Voltage dips, short interruptions and voltage variations on power supply input lines IEC 61000-4-11 (2004)	According to 60601-1-2, table 4-13: (>95 % dip in UT) for 0,5 cycle positive and negative half period. (95 % dip in U-) for 1 period (30 % dip in UT) for 25 cycles  (>95 % dip in UT) for 5 sec	(>95 % dip in UT) for 0,5 cycle positive and negative half period. (95 % dip in U-) for 1 period (30 % dip in UT) for 25 cycles (>95 % dip in UT) for 5 sec	Mains power quality should be that of a typical commercial or hospital environment. If the user of the Iconic requires continued operation during power mains interruptions, it is recommended that the Iconic be powered from an uninterruptible power supply or a battery.

Power frequency (50/60 Hz) magnetic field IEC 61000-4-8 (2009)	30 A/m, 50 Hz and 60 Hz	30 A/m, 50 Hz and 60 Hz	Power frequency magnetic fields should be at levels characteristic of a typical location in a typical commercial or hospital environment.
NOTE $U_T$ is the a.c. mains voltage prior to application of the test level.			
<b>Guidance and manufacturer's declaration - electromagnetic immunity</b>			
The Iconic is intended for use in the electromagnetic environment specified below. The customer or the user of the Iconic should assure that it is used in such an environment.			
Immunity test	IEC 60601 test level	Compliance level	Electromagnetic environment - guidance
Conducted RF IEC 61000-4-6	6 Vrms with 80 % AM @ 1KHz. 150 kHz to 80 MHz	6 Vrms with 80 % AM @ 1KHz	<p>Portable and mobile RF communications equipment should be used no closer to any part of the Iconic, including cables, than the recommended separation distance calculated from the equation applicable to the frequency of the transmitter.</p> <p><b>Recommended separation distance</b></p> $d = 1.2\sqrt{p}$
Radiated RF IEC 61000-4-3	3 V/m with 80 % AM @ 1kHz 80 MHz to 2,5 GHz	3 V/m with 80 % AM @ 1kHz	$d = 1.2\sqrt{p} \quad 80 \text{ MHz to } 800 \text{ MHz}$ $d = 2.3\sqrt{p} \quad 800 \text{ MHz to } 2.5 \text{ GHz}$ <p>where P is the maximum output power rating of the transmitter in watts (W) according to the transmitter manufacturer and d is the recommended separation distance in meters (m).</p> <p>Field strengths from fixed RF transmitters, as determined by an electromagnetic site survey<sup>a</sup> should be less than the compliance level in each frequency range.<sup>b</sup></p> <p>Interference may occur in the vicinity of equipment marked with the following symbol:</p> 
NOTE 1 At 80 MHz and 800 MHz, the higher frequency range applies.			
NOTE 2 These guidelines may not apply in all situations. Electromagnetic propagation is affected by absorption and reflection from structures, objects and people.			
<p>a. Field strengths from fixed transmitters, such as base stations for radio (cellular/cordless) telephones and land mobile radios, amateur radio, AM and FM radio broadcast and TV broadcast cannot be predicted theoretically with accuracy. To assess the electromagnetic environment due to fixed RF transmitters, an electromagnetic site survey should be considered. If the measured field strength in the location in which the Iconic is used exceeds the applicable RF compliance level above, the Iconic should be observed to verify normal operation. If abnormal performance is observed, additional measures may be necessary, such as re-orienting or relocating the Iconic.</p> <p>b. Over the frequency range 150. kHz to 80 MHz, field strengths should be less than 3 V/m.</p>			

<b>Recommended separation distances between portable and mobile RF communications equipment and the Iconic</b>			
The Iconic is intended for use in an electromagnetic environment in which radiated RF disturbances are controlled. The customer or the user of the Iconic can help prevent electromagnetic interference by maintaining a minimum distance between portable and mobile RF communications equipment (transmitters) and the Iconic as recommended below, according to the maximum output power of the communications equipment.			
Rated maximum output power of transmitter W	Separation distance according to frequency of transmitter m		
	150 kHz to 80 MHz $d = 1.2\sqrt{p}$	80 MHz to 800 MHz $d = 1.2\sqrt{p}$	800 MHz to 2,5 GHz $d = 2.3\sqrt{p}$
0.01	0.12m	0.12m	0.23m
0.1	0.38m	0.38m	0.74m
1	1.2m	1.2m	2.3m
10	3.8m	3.8m	7.4m
100	12m	12m	23m
For transmitters rated at a maximum output power not listed above, the recommended separation distance d in meters (m) can be estimated using the equation applicable to the frequency of the transmitter, where P is the maximum output power rating of the transmitter in watts (W) according to the transmitter manufacturer.			
NOTE 1 At 80 MHz and 800 MHz, the separation distance for the higher frequency range applies.			
NOTE 2 These guidelines may not apply in all situations. Electromagnetic propagation is affected by absorption and reflection from structures, object and people.			



Annex1: contents of packaging

The following accessories are included in Iconic family packaging according to the customer's order:

<b>Item</b>	<b>Quantity</b>
<b>Iconic device</b>	1
<b>Single use patient plate</b> PLACOM Pre-gelled electrosurgical Plates Comepa Industries	10
<b>Plate cable</b> NIPAK Company	2
<b>Main power cable</b>	1
<b>Single pedal footswitch</b>	1
<b>Two pedal footswitch</b> Trademark: SUNS REF: FS-82-SP	1
<b>User manual</b>	1
<b>General tips label (for top of device)</b>	1
<i>Only For IS410S</i>	
<b>Single use Monopolar instrument</b> M.A. Arain & Brothers REF: 231-014-3	2
<b>Reusable Bipolar cable</b> Metko co. REF : ESU-BP/BA LOT : 16003	1
<b>Bipolar forceps</b> Tecno co.	1

## **Kavandish System Co.**

---

Factory: Tel: (+9821) 76250635-38 Fax: (+9821) 76250637 [www.kavandish.com](http://www.kavandish.com)  
Sales Office: Tel: (+9821) 88531318-19 Fax: (+9821) 88519063 [info@kavandish.com](mailto:info@kavandish.com)