

User Manual

ELECTROSURGICAL UNIT



MEG1



MEG1-E



MEG1-R



KAVANDISH SYSTEM

User Manual

MEG1

Family

Electrosurgical Generators

V2.1
June 2023

Preface

This User Manual and the device which is described have been only prepared for qualified medical professionals who have been trained for the particular technique and surgical procedure to be performed. This manual is designed only for using MEG1 family devices, products of Kavandish System Company. More technical information for authorized service personnel of this company and its authorized representatives is available in the Service Manual.

Made in IRAN
Printed in IRAN



Kavandish System Co.
Pardis technology park, Damavand Rd. 20th Km. Tehran, Iran.
Factory: Tel: (+98-21) 76250635-38 Fax: (+98-21) 76250639
Sales Office: Tel: (+98-21) 88531318-19 Fax: (+98-21) 88519063
E-mail: info@kavandish.ir
www.kavandish.ir



Trionara Technologies AB.
Polygonvägen 21, 18766, Täby, Sweden.
Phone Number : +46 31 135514
Email: info@trionara.com



Intended Use

MEG1 family devices are electrosurgical generators used for cutting and coagulation of biological tissue in general and specialized surgery. The devices use HF (>100Khz) electrical current thermal effects for obtaining cutting and coagulation. Intended patient population can be of any age, weight or gender.

Conventions Used in this Manual

WARNING

Indicates a potentially hazardous situation which, if it is not avoided, it could result in death or serious injury.

CAUTION

Indicates a potentially hazardous situation which, if it is not avoided, it may result in medium or minor injury.

NOTICE

Indicates an operating tip, maintenance suggestion or a hazard which may damage the device.

Warranty

- This product is warranted for 24 months from the date of device delivery to the user. During this period any failure in the device due to defective parts or system error caused by manufacture will be fixed free of charge in the company.
- To receive the warranty card, please complete the yellow sheet related to warranty card request and post it to company at the earliest time (before sending it, note that it has been filled correctly and completely).
- Failure due to negligence in transportation or incorrect use of the product will not be covered by the warranty.
- During the warranty period, any repair must be carried out by Kavandish System Company or its authorized representatives; otherwise the warranty will be canceled.
- Accessories are not covered by the warranty and in case of damage must be replaced.

Guarantee

- Kavandish System Company agrees to repair and provide the spare parts for 10 years from the delivery date of the product.

Contents

- Chapter 1: Overview and General Features.....1**
- Introduction 2
- Some advantages and features of the MEG1 electrosurgical unit 2
- To User..... 2
- Intended Use 2
- Front Panel Features 3
- Back Panel Features 8
- Signs Used on Front and Back Panels..... 9
- Chapter 2: General Warnings and Safety Notices11**
- Launching and Using the Device 12
- Fire Hazard..... 14
- Electromagnetic Interference..... 15
- Accessories..... 16
- Footswitch 18
- Monopolar 18
- Plate 18
- Bipolar 20
- After surgery..... 21
- Repairing or Servicing 21
- Chapter 3: Installation and Launching.....22**
- Before Launching 23
- Turning on the Device..... 23
- Contents of packaging..... 24
- Checking the Device before Using in Operating Room 24
- Chapter 4: Monopolar Technique.....26**
- Information Regarding Monopolar in Receptacles Module Section 27
- Monopolar Instruments 27
- Monopolar Electrodes 29
- Patient Plate..... 30
- Plate Indicators on the Panel..... 30
- Patient Plate Monitoring System..... 30
- Material and Dimension Selection of Patient Plate..... 31
- Footswitch 33
- Information Regarding Monopolar Cut in Mode and Power Setting Section 34
- Monopolar Cut Modes 34

Information Regarding Monopolar Coag. in Mode and Power Setting Section.....	35
Monopolar Coag. Modes.....	35
Power Level Changes in Monopolar.....	36
Output Power Selection in Monopolar.....	36
Method of Monopolar Cut Setting.....	37
Method of Monopolar Coag. Setting.....	37
Method of Using Monopolar.....	38
<u>Chapter 5: Bipolar Technique.....</u>	39
Information Regarding Bipolar Receptacle and its Accessories.....	40
Bipolar Instruments.....	40
Bipolar Coag. Forceps.....	41
Bipolar Cut Scissors.....	41
Footswitch.....	42
Information Regarding Bipolar in Mode and Power Setting Section.....	43
Bipolar Modes.....	44
Power Level Changes in Bipolar.....	44
Output Power Selection in Bipolar.....	45
Method of Bipolar Setting.....	45
Method of Using Bipolar.....	46
<u>Chapter 6: LCD Display Pages and How to Use them.....</u>	47
LCD Display Applications.....	48
Settings Pages.....	49
How to Enter the Setting Pages.....	49
How to Select Micro Surgery, General Surgery and TUR Modes.....	49
Programming Pages.....	50
How to Enter Programming Pages.....	50
How to Recall the Preset Program in the Memory.....	50
How to Save a Program.....	51
Display Page of Alarm Codes which are Generated while Working with the Device.....	52
How to Observe the Logged Alarm Codes.....	52
How to Set Delay Time in Auto Start of Bipolar Coag. Mode.....	52
<u>Chapter 7: Alarm System.....</u>	54
Alarm Conditions.....	55
Failure in Patient Plate Condition Alarm.....	56
System Memory Failure Alarm.....	56
Alarm Conditions Group.....	56
Alarm Conditions Priority.....	56
Alarm Signals.....	57
Alarm Signals Characteristics with Medium Priority.....	57
Alarm Signals Characteristics with Low Priority.....	57

Alarm Signals Generation Ranking.....	57
Alarm Logging System in the Memory.....	57
Information Conditions.....	59
Information Signals Characteristics.....	59
Information Signals Rank in Comparison with Alarm Signals.....	59
<u>Chapter 8: Maintenance and Repair</u>.....	60
Manufacture Responsibility.....	61
Routine Maintenance.....	61
Safety Checks.....	61
Cleaning and Disinfecting.....	61
Cleaning Accessories.....	62
After Sales Service.....	62
<u>Chapter 9: Technical Specifications</u>.....	63
Dimensions and Weight.....	64
Input Power.....	64
Operating Parameters.....	64
Transport and Storage Parameters.....	64
Internal Memory.....	64
Displays.....	64
Generator Activation Tone.....	64
Current Consumption.....	65
High Frequency Leakage Current.....	65
Low Frequency Leakage Current.....	65
Patient Plate Monitoring System.....	65
Duty Cycle.....	65
Output Characteristics*.....	66
Standards.....	66
Drip Proof (IEC 60601-2-2).....	66
IEC Classification.....	66
Maximum Output Power Graphs versus Load Resistance.....	67
Output Power Graphs versus Adjusted Power Level.....	70
Maximum Output Voltage Graphs versus Adjusted Power Level.....	73
<u>Chapter 10: EMC Compliance</u>.....	76
<u>Annex 1: Special Features of MEG1-E for Endoscopy</u>.....	78
Introduction.....	79
Front panel of Meg1-E.....	80
Back panel of Meg1-E.....	81
Accessories of Meg1-E.....	81
Cutting Modes and Power Selection.....	82

Coagulation Modes and Power Selection	83
Power Level Changes in Monopolar	84
ENDO-CUT technique (Papillotomy and Polypectomy)	84
Technical features of ENDO-CUT modes	84
Main Benefits of ENDO-CUT modes	84
The setting of ENDO-CUT modes	85
Information Regarding EndoCut Modes setting and related receptacles	85
Important points when using ENDO-CUT	86
Coagulation intensity in ENDO-CUT	86
How to use ENDO-CUT	87
Using Argon Plasma Coagulation	87
Alarm Logging System in the Memory	87
Technical Specifications of Meg1-E	88
Dimensions and Weight	88
Input Power	88
Internal Memory	88
Displays	88
Current Consumption	89
High Frequency Leakage Current	89
Low Frequency Leakage Current	89
Output Characteristics*	89
Standards	90
Drip Proof (IEC 60601-2-2)	90
IEC Classification	90
Maximum Output Power Graphs versus Load Resistance in Meg1-E	90
Output Power Graphs versus Adjusted Power Level	93
<u>Annex 2: Special Features of MEG1-R For Radiofrequency Surgery</u>	94
Introduction	95
Front panel of Meg1-R	96
Back panel of Meg1-R	97
Accessories of Meg1-R	97
Signs Used on Meg1-R	98
Volume Adjustment	98
Cutting Mode and Power selection	99
Coagulation Mode and Power Selection	100
Power Level Changes in Monopolar	101
Power Level Changes in Bipolar	101
Saving alarms in the Memory	102
Technical Specifications of Meg1-R	103
Dimensions and Weight	103

Input Power	103
Internal Memory	103
Displays.....	103
Current Consumption	103
High Frequency Leakage Current	103
Low Frequency Leakage Current.....	103
Output Characteristics*	104
Standards.....	104
Drip Proof (IEC 60601-2-2)	104
IEC Classification	104
Maximum Output Power Graphs versus Load Resistance in Meg1-R	105
Output Power Graphs versus Adjusted Power Level in Meg1-R	106
<u>Annex 3: Special Features of MEG1 with Bipolar TUR.....</u>	107
Introduction	108
Front panel of Meg1 with Bipolar TUR	109
Monopolar Cutting Modes and Power selection	112
Monopolar Coagulation Modes and Power selection	113
Bipolar Modes and Power selection	114
Power Level Changes in Bipolar	115
Alarm Conditions.....	115
Technical Specifications of Meg1 with Bipolar TUR	116
Dimensions and Weight	116
Input Power	116
Internal Memory	116
Displays.....	116
Current Consumption	116
High Frequency Leakage Current	116
Low Frequency Leakage Current.....	116
Output Characteristics*	117
IEC Classification	117
Maximum Output Power Graphs versus Load Resistance in Meg1 with Bipolar TUR	117
Output Power Graphs versus Adjusted Power Level in Meg1 with Bipolar TUR	119
Maximum Output Voltage Graphs versus Adjusted Power Level in Meg1 with Bipolar TUR.....	120

Chapter 1

Overview and General Features

- Introduction
- Front Panel Features
- Back Panel Features
- Signs Used on Front and Back Panels



Introduction

MEG1 family electrosurgical generator are modern phenomena, perfect and applicable in all general and specialized surgery rooms, and enjoy the state of the art technology using the latest techniques in electrical and electronic design while complies with the latest international safety codes and standards and providing broad capabilities in electrosurgery.

MEG1 electrosurgical generators are designed to provide Monopolar Cut, Monopolar Coagulation (Coag.), Bipolar Cut and Bipolar Coag Techniques. It has the most useful modes in general and specialized surgeries with wide output power range from less than 0.2 watt up to nearly 400 watt.

Some advantages and features of the MEG1 electrosurgical unit

- **Microprocessor based control and LCD Interface**

To achieve best digital control a microprocessor is used.

For displaying and adjusting operating modes (General, Micro & TUR), access to the memory to define the desired settings by the surgeon, displaying warnings and help messages and ease of communication with user, an LCD is used.

- **Programmable memory**

Programmable memories are usable with EEPROM technology, so that surgeons can select their desired setting using special menus on the LCD display and save it in their name and load it if needed.

- **Display of device output power in terms of watts at nominal load**

This ability allows the surgeon to choose the output power more precisely and prevents the surgeon from making mistakes due to differences in nominal powers and power curves that defined for the device with a relative scale.

Also by providing high resolution in low powers, choosing very low powers would be possible for delicate surgeries. Displayed power is related to a range around the nominal load.

To User

This operation manual is intended to serve as an aid in the proper setup, installation and operation of the unit. The additional technical information is available in the service manual. All essential details of the equipment and all action required on your part are clearly presented and explained. Only qualified physician should use this equipment. Please carefully study this manual and keep on hand for quick reference.

Intended Use

Meg1 devices are electrosurgical generators used for cutting and coagulation of biological tissue in general and specialized surgery. The devices use HF (>100 KHz) electrical current thermal effects for obtaining cutting and coagulation. Intended patient population can be of any age, weight or gender.

Front Panel Features

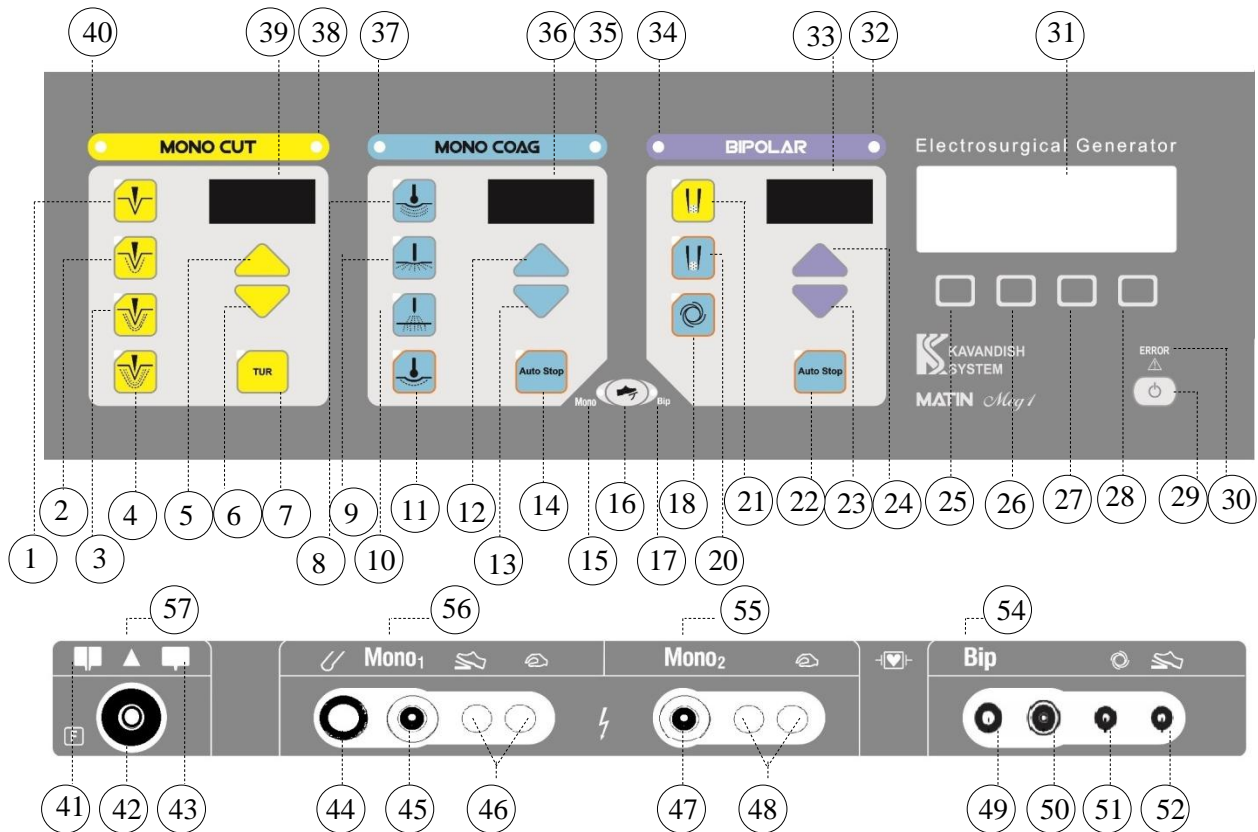

1. This pushbutton and indicator light selects pure cutting mode. Un-modulated HF current at high power but due to relatively low voltage the destruction of the adjacent tissues is minimized.
2. This pushbutton and indicator light selects Blend I. Slightly modulated HF current so more coagulated occurs in comparison with pure cutting.
3. This pushbutton and indicator light selects Blend II. Medium-modulated HF current so the adjacent tissues are coagulation more intensely than Blend I.
4. This pushbutton and indicator light selects Blend III. Strongly modulated HF current so the adjacent tissues are coagulated more than the others. It is particularly well suited to incise tissues that are bleeding profusely.
5. This pushbutton increases the monopolar power output (Monopolar1,2) in cut mode.
6. This pushbutton decreases the monopolar power output (Monopolar1,2) in cut mode. If you press buttons 6 and 5 one time or hold your finger on them, you will observe changes of the level on digital display 39. These changes are applied in the form of separate steps in order that selecting the levels can be fulfilled more accurately. Notice that from 1 to 50 levels, the rate of level will change step by step, from 50 to 102 levels it will change two steps by two steps, from 105 to 200 it will change five steps by five steps and from 200 to the maximum level the changes will be ten steps by ten steps. It should be mentioned that chosen level is proportionate to the output power. The rate of level may be selected from the range of 1 level to nominal power in every monopolar mode.

7. This pushbutton and indicator light selects TUR mode. This mode is intended to be used for surgery in the fluid environment for instance urinary and prostate surgeries

8. This pushbutton and indicator light selects swift coagulation mode.

This mode is well suited for quick coagulation of tissues by utilizing electrodes with a large diameter such as ball, plate electrodes or forceps.

9. This pushbutton and indicator light selects forced coagulation.

This mode is well suited for deep coagulation of tissues by utilizing electrodes with a small diameter.

The maximum output power is less than the previous mode but it is modulated more intensely. It is useful for electrode with thin diameter or doing deep coagulation.

10. This pushbutton and indicator light selects spray coagulation or fulguration.

The crest factor of waveform is more than the others. It is suited for superficial coagulation and producing the electrical arc between the electrode and the tissue.

You should use this mode to minimize incision effects or rupture of tissues.

NOTICE

In case of selecting spray mode, it is possible to activate both monopolar 1 and monopolar 2 output simultaneously, whereas we are not permitted to activate both of them in the other modes. In case of any demand to activate both monopolar (1, 2) output, the priority will be given to monopolar 1 and the second one will not have an output at that time.

11. This pushbutton and indicator light selects soft coagulation mode. It is intended to apply this mode for soft coagulation without suffering from carbonizing the tissue and adhesion of the tissue to the electrode.

The rate of output power in the soft coagulation mode is less than the output power of three previous modes.

12. This pushbutton increases the monopolar output power in coagulation mode.

13. This pushbutton decreases monopolar output power in coagulation mode.

If you press buttons 12 and 13 or hold your finger on them, you will observe changes of the level on digital display 36. These changes are achieved in the form of separate steps in order that selecting the levels can be fulfilled more accurately. Notice that from 1 to 50 levels, the rate of level will change step by step, from 50 to 102 levels it will change two steps by two steps, from 105 to 200 levels it will change five steps by five steps and from 200 to the maximum level the changes will be ten steps by ten steps. It should be mentioned that chosen level is proportionate to the output power. The rate of level can be selected from the range of 1 level to the nominal power in every monopolar mode.

It should be mentioned that if you press the button and hold it more than 1 second continuously in this mode, the speed of changing the level will increase to make the adjustment easier.

14. This pushbutton and indicator light select Auto Stop mode for monopolar coagulation.

If you want to stop coagulation at the time of optimum coagulation automatically in soft coag mode, you can choose Auto Stop mode. Consequently the equipment will measure electric resistance changes of the tissue which is under coagulation. When the tissue reaches to the optimum coagulation stage (before carbonizing and desiccation of the tissue), the output will be terminated automatically and related audible alarm will be sounded. Notice that you can choose this mode (Auto Stop) only in the soft mode and there will be no reaction if you press this button when you are in other modes.

15. This indicator light switches pedal footswitch to monopolar mode.

16. This pushbutton switches footswitch to bipolar or monopolar generator.

A single press of the button 16 changes the position of lights 15, 17.

Pressing the pedal in monopolar mode, activates monopolar output.

This has no effect on bipolar output. When you press the pedal in the Bipolar mode, situation is exactly reversed.

17. This indicator light selects bipolar mode for pedal footswitch.

18. This pushbutton and indicator light selects auto-start mode with programmable delay. if footswitch has been selected for Bipolar, The Auto Start mode Will Change to manual mode by pressing the footswitch.

Auto Start Bipolar coagulation: The bipolar output is activated after the two tips of forceps touch the tissue. It is impossible to activate the bipolar output automatically whenever monopolar output is activated.

20. This indicator light selects manual Bipolar Coagulation.

Bipolar output is activated only by pressing footswitch.

21. This indicator light selects manual Bipolar Cutting.

Bipolar output is activated only by pressing footswitch.

22. This pushbutton and indicator light selects Auto Stop mode for Bipolar coagulation.

If you want to stop coagulation at the time of optimum coagulation automatically in Bipolar Coag mode, you can choose Auto Stop mode (the other explanations is similar to part 14). Moreover you should notice that Auto Stop mode is always inactive in Bipolar cut mode, so pressing this button in this mode, do not make anything activate.

23. This pushbutton decreases Bipolar output power.

If you press buttons 23 and 24 one time or hold your finger on them, you will observe changes of the level on digital display 33. These changes are achieved in the form of separate steps in order that selecting the levels can be fulfilled more accurately.

Notice that from 0.1 to 1.0 level, the rate of level will change 0.1 step by 0.1 step, from 1.0 to 5.0 level it will change 0.2 by 0.2 step, from 5 to 10 level it will change 0.5 by 0.5 steps, from 10 to 20 level it will change step by step and from 20 to 100 level the changes will be two steps by two steps. Also the rate of chosen level is almost equal to output power and can be selected from the range of 0.1 w to nominal power.

24. This pushbutton increases the Bipolar output power.

25. This pushbutton selects a mode in order to return to the previous page in LCD display (LCD adjustment).

26. This pushbutton selects the mode to move LCD display downwards to select desired options.

27. This pushbutton selects the mode to move LCD display upwards to select desired options.

28. This pushbutton selects and confirms the continuation of the operation or operation path; in the LCD display (complete explanation about various menus of LCD will be notified in chapter 4, under the title of “Introduction of LCD display pages”).

29. This pushbutton sets the equipment in the standby mode. In order to activate standby mode, you should press this button and hold your finger on it 1 to 2 seconds. In this case the equipment will not run any command. Notice that whenever you exit from this mode, the unit will turn on and operate commands. In order to exit from the standby mode, press the button again and hold it 1 to 2 seconds

(when the equipment is in the standby mode, all of previous saved data will be reserved in the unit memory and as soon as the unit exits from this mode, all of saved data will be displayed. However, electric current interruption will disappear all of the saved data).

- 30. This indicator light informs you that an error has been occurred because of an internal damage, or operator mistake. (refer to chapter 3 for more details)
- 31. LCD display which is used to display and adjust modes, memories, and messages.
- 32. This indicator light indicates the activation of Bipolar coagulation generator.
- 33. This digital display indicates the Bipolar output power.
- 34. This indicator light indicates the activation of Bipolar cutting.
- 35, 37. These indicator lights indicate the activation of monopolar coagulation generator.
- 36. This digital display indicates monopolar output power in coagulation mode.
- 38, 40. These indicator lights indicate the activation of monopolar cut generator.
- 39. This digital display indicates the monopolar power output in cut mode.
- 41. This indicator light indicates the connection of Dual Pad plate to the unit and indicates that the contact quality of plate with patient is acceptable.
- 42. Connection place of single and dual pad patient plate to the unit.
- 43. This indicator light indicates the connection of Single Pad plate to the unit.
- 44. Connection place of monopolar pen to the unit. The connector diameter is 8 mm. There is no need

to any adaptor because this connector is planned for the equipments such as Endoscopy, Laparoscopy or TUR units which are compatible with 8 mm diameter standard. In case that these units have been manufactured according to 4mm diameter standard, you may utilize next connector (45). In this case the unit will be activated only by footswitch.

WARNING

When you are utilizing this connector as an output, all of monopolar1 output terminals have voltage too, so take sufficient care before operation. Moreover, when monopolar 1 output is activating, the monopolar pen which is connected to this connector also have voltage. Therefore apply necessary precautionary actions and never connect two cautery pens to the monopolar 1 connectors simultaneously.

- 45. Connection place of martin type monopolar connector (Mono1) to the unit (Complied with Martin and Berchtold model) and also connector of Endoscopy, laparoscopy, and TUR units which are compatible with 4mm diameter standard
- 46. Auxiliary terminals, only for connection of 3-pin Handel to monopolar1 output.

NOTICE



These terminals are used only with 3-pin hand switching accessories.

Connecting one-pin foot switching accessories to these terminals may result in product damage. Use only the 44 and 45 output receptacle for TUR or Endoscopy or Laparoscopy.

47. Connection place of martin type monopolar connector (Mono2) to the unit (complied with Martin and Berchtold model).

The unit is equipped with Monopolar 2 output so that two surgeons operate on a patient simultaneously while utilizing two separate pens, for instance during coronary artery transplantation surgery, utilizing two separate monopolar pens is unavoidable.

It should be mentioned that monopolar2 output is activated only through finger switch and does not activate by footswitch.

48. These Auxiliary terminals, only for connection of 3-pin to monopolar2 output.

50. Bipolar forceps jack (for Martin & Berchtold Standard).

49, 51 and 49, 52. Connection place of Bipolar pen complied with American Company type and 4mm standard connector.

54. This indicator light indicates the activation of bipolar generator.

55. This indicator light indicates the activation of monopolar2 output.

56. This indicator light indicates the activation of monopolar1 output.

57. This warning indicator light is related to patient plate.

Whenever the patient plate disconnects from the unit or a problem occurs along the plate connection path which causes the impedance discrepancy between two tips of connection path increased more than 150 ohms, this warning light will turn on.

Back Panel Features

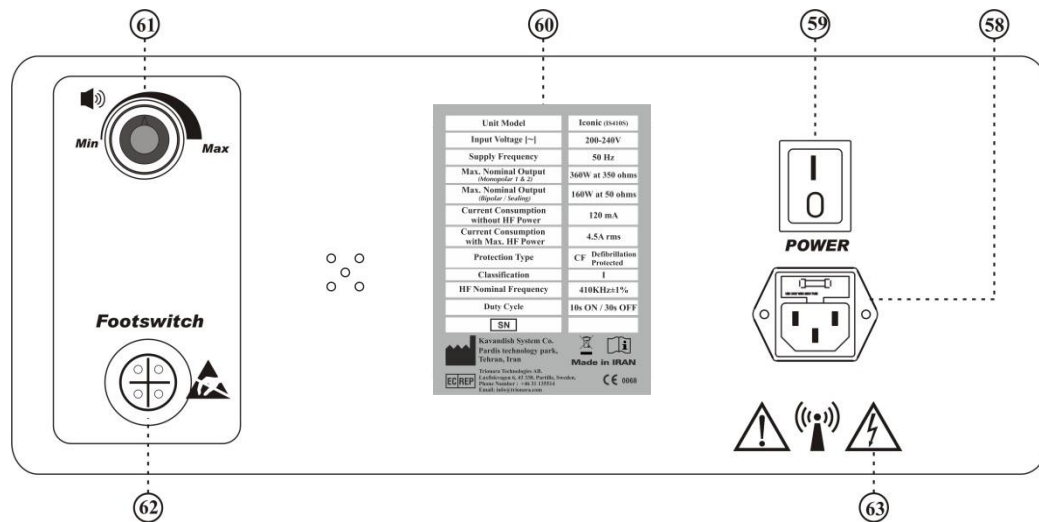

58. Line cord receptacle (200–240(VAC), 50Hz) and Input Fuse (5A/250V/S/5*20mm) place.

59. Main power switch.

60. Manufacturer's identification label.

61. Audio volume dial

Rotate the dial clockwise to increase volume and vice versa. The dial just affects on volume that is sounded during activating the generator. It does not have any effect on the alarming sound of neutral electrode.

62. Pedal footswitch receptacle.

63. A warning sign which indicates possibility of electric shock due to direct contact with steel parts of connectors or internal circuits of the unit because high voltage exists in these parts.

Signs Used on Front and Back Panels



The degree of protection against electric shock is of Cardiac Floating (CF) type and low frequency leakage currents are negligible. Also the device is protected against high voltage due to defibrillator use for patient.



Adjacent output connector can be activated with hand switch



Adjacent output connector can be activated with footswitch



Connection place of single and dual pad patient plate.



Bipolar receptacle



Adjacent output connector may be activated automatically, only through electrode contacting tissue, without pressing footswitch or hand switch.



Hazard of high voltage in the adjacent output connector



Adjacent connector can be used for TUR surgeries



Plate and other applied parts such as Monopolar and Bipolar instruments are completely isolated from earth and supply mains outlet at both high and low frequencies.



Study the instruction manual.



This device is marked with the WEEE symbol according to Directive 2002/96/EC. Devices marked with this symbol must be put into the separate waste collection for electrical and electronic devices. Please recycle where facilities exist.

Check with your Local Authority or retailer for recycling advice .



Caution

Study all related sections in User Manual and or Service Manual before installation and operation of the device and or opening it for repair.



There is the possibility of electromagnetic interference on surrounding electronic units.



High voltages warning



Electrostatic discharge warning for connectors sensitive to electrostatic discharge and precautions should be made when working with them.

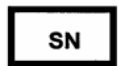

Device serial number



Manufacturer



Authorized representative in the European Community

Chapter 2

General Warnings and Safety Notices

- Launching and Using the Device
 - Fire Hazard
 - Electromagnetic Interference
 - Accessories
 - Monopolar
 - Bipolar
 - After surgery
 - Repairing or Servicing

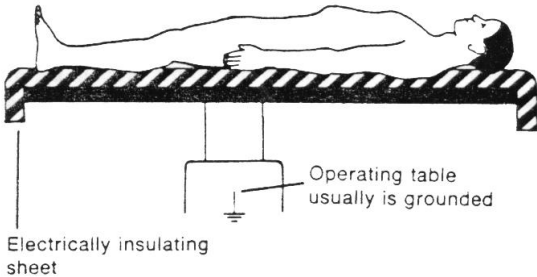

Launching and Using the Device

WARNING
Study and follow all instructions and safety points provided with this manual.
Check device performance in terms of appearance and safety alarms.
Electric shock hazard: use earthed outlets for connecting to supply mains.
In order to observe safety issues and avoid unwanted side effects, always use the lowest possible power which achieves the desired surgical effect. Of course in Continuous Argon and Pulsed Argon modes that the risk of gas embolism in lower power is increased, it's better to use higher powers.
Receptacles that are marked with electrostatic discharge warning symbol  (IEC 60417-5134), are sensitive to electrostatic discharge and precautions should be made when working with them. Thus, make ensure of lack of electrostatic load accumulation, when connecting cables to these special connectors. Typically accumulated static load can be discharged from device body.
The patient's body shouldn't be in contact with metal components connected to the earth or with significant capacitance to the earth (for example, metal parts of the operating table, metal base of injection device, etc.) or with moist or wet fabrics. This may cause burn due to high frequency leakage current and high density of current on small surfaces (antistatic sheet is recommended).
Since the elastic surfaces on the surgery bed usually have small amount of electrical conductivity to prevent electrostatic load accumulation; therefore, they're not suitable for complete separation of the patient from the metal parts. Use dry, waterproof and thick plates for separating the patient from the operating bed and metal items, use moisture absorption towels to prevent fluids concentration under the patient.
 <p style="text-align: center;">Method of positioning patient on the operating table</p>
Electrodes, monitoring equipment probes, irritant and imaging equipment can direct high frequency current leakage and therefore causes unwanted burn. Thus, when using high frequency electrosurgical device with these equipment; it's necessary that each electrode or monitoring probe be placed, if possible, far from surgical electrodes and patient plate and the minimum distance of 15 cm be observed between active electrode and ECG electrodes. Using needle electrodes is not allowed for monitoring and if you're forced to use this type of electrodes, separate cables of needle electrodes from the monitor during electrosurgical device activation. In any case it is recommended that high frequency current limiter monitoring systems is utilized.



WARNING
<p>In order to reduce the risks of high frequency current leakage from unwanted directions, use the following measures:</p> <ul style="list-style-type: none">• As much as possible use low voltage modes, like Pure mode that has lower voltage than Blend mode and also Soft or Swift modes that have lower voltage than Spray mode.• Avoid keeping the device active in open circuit mode that active electrode is not in electrical contact with tissues.
<p>In case you notice device output power is less than normal, check the following issues before increasing device power.</p> <ul style="list-style-type: none">• Make sure that the desired position on the device panel, footswitch or hand switches are correctly selected.• In Monopolar technique, make sure of correct and complete plate connection.• Check cables and connectors connection to the device.• Clean electrodes tips completely from adhesives material.
<p>If a failure occurs in the system, it is possible that device output power (in contrast with the selected power) increases.</p>
<p>If instruments are not used temporarily, keep them separate from surgery area and contacting with patient or conductive objects that are in contact with the patient. This prevents patient burn in case of unwanted device activation (due to accidental switch press).</p>
<p>Take the following steps to reduce the risks of minimally invasive surgery (such as laparoscopy) that sometimes burn occurs in the area not visible by the surgeon.</p> <ul style="list-style-type: none">• Check insulation quality and note that any crack, gap and ripple can be a sign of insulation weakness and a direction for current leakage.• Use minimum power and modes which uses minimum voltage.• Active the generator just when active electrode is contacted with tissue.• If active electrode is in the vicinity of metal parts or in contact with them, the generator should not be activated.• Use Bipolar method whenever it is possible.• If possible, use All metal cannula that external metal sheath covers all cannula system to reduce the possibility of leakage due to capacitated coupling.
<p>Do not wind instruments and plate cables around metal objects; this can cause current leakage through metal objects and also high frequency induction in these objects causes them to hot up and create burn.</p>
<p>Use isolated ocular parts in cases such as endoscopy and TUR and note that because active electrode is in constant contact with tissues, any unwanted activation of the generator can cause burn in the active electrode contact with tissue.</p>
<p>Avoid coagulation as long as possible in the method that between active electrode and hemostat instrument, electric arc is established. In this method, first contact metal to metal and then activate the generator, this reduces unwanted shocks to surgeons</p>
<p>Neuromuscular stimulation and following inadvertent consequences such as spasms or muscle contractions may occur in modes with high output voltage such as spray mode due to low frequency harmonics in electric arc. The device has been designed to minimize such stimulations.</p>

WARNING
If alarm is heard from the device, check the device status and make sure of its correct operation condition before reusing it.
To minimize adhesive effects of active electrodes to tissues during coagulation, do not activate the generator before electrode contact with tissue and stop the current upon sufficient coagulation and keep the electrodes always cleans.
Active electrodes may be hot due to electrical sparks and or contact with tissue during cutting and coagulation and their contact with other tissues can cause unwanted burn.
In cases the active electrode has constant contact with tissue even when the generator is not active, (eg. in endoscopy or TUR) more attention should be paid to visual and auditory signs of generator activation; and when there is no need to activate generators, for example during electrode take out from the patient's body, definitely set the output power displays in lack of output power mode or turn off the device.
In case generator is unwantedly activated and if electrodes are directly or indirectly through wet fabric or other conductor objects in contact with patient's body, it can cause burn. Unwanted generator activity can be due to accidental activation of pedal or hand switches or a failure in cable of accessories or the device itself; if connecting pedal or pen to device causes unwanted device activation, the failure is due to accessories, and if without connecting them to the device, generator is activated, the failure is due to the device. To avoid unwanted burns, never place active electrodes such that directly or through conductive objects or wet fabrics be in contact with patient.
Be careful in using of ESU in thin wall organs like intestine to avoid undesirable perforation. Set power as low as possible.
To prevent the staff's burn, avoid contact with patient during the activation of the ESU.
During activation, prevent patient body movement in the surgery site.
In status do not need any generator activation for example, when you withdraw the electrode from the patient's body, put output power displays in minimum level or use standby mode.

CAUTION
Some particles containing smoke and vapor are released in the environment due to surgery with electrosurgical device. The particles contain toxic chemicals, carbonized tissue, blood particles, bacteria and little amount of carbon dioxide. Therefore it is recommended to discharge the smoke by proper means and install suitable filters. Also the recommendations in this regard should be given to the operating room personnel and exhaust channels and open areas should not be used for smoke discharge. During surgery masks with high filtering effect with the lowest carbon particles inhalation must be used.

NOTICE
For ease in future follow-ups, register the device serial number in the patient's records.

Fire Hazard

WARNING

**WARNING**

There is the risk of gases or flammable substances combustion when using electrosurgical device. Thus, avoid the flammable substances contact with electrodes of electrosurgical device.

Use of electrosurgery in o₂ rich environments increases the risk of fire. Therefore, take measures to reduce the o₂ concentration at the surgical site. Avoid enriched o₂, n₂o atmospheres near the surgical site.

If the surgery is performed in the region of the head and chest, do not use flammable anesthetics or oxidant gases such as nitrogen oxide (N₂O) and oxygen. If use is unavoidable, you must extract the combustion-supporting gases before performing electrosurgery.

There is the risk of flammable solutions accumulation under the patient or body's dimples such as umbilicus and body cavities such as vagina. It's better to dry any liquid accumulated in these places before using the device.

Avoid flammable gases that are naturally produced and are accumulated in body cavities such as intestines.

Extract the flammable endogenous gases in the gastrointestinal tract before performing electrosurgery or irrigate with co₂.

Some materials such as string, cotton and gauze when being saturated with oxygen, may be flamed when it comes to contact with sparks produced in the normal use.

If flammable disinfectant materials (those which have alcohol base) are used, let them being evaporated before covering the patient and avoid flammable material contact with electric arc during surgery.

Electromagnetic Interference

WARNING

There is possibility of electromagnetic interference between electrosurgical device and adjacent electronic devices. Therefore, in case of observing unusual condition in adjacent devices, consider the above possibility and apply special measures of electromagnetic compatibility to solve the interferences.

In case interference occurs only when the generator is activate, then following steps can reduce the interference:

- Reducing the device output power.
- Using low-voltage modes, for example Pure mode instead of Blend mode or Soft or Swift modes instead of Spray mode.
- Using Bipolar technique instead of Monopolar technique.
- Increasing the distance of device and its external cables from the unit which is affected due to interference (such as monitor).

WARNING

If patient has pace maker or other electronic devices implanted inside the body, there is risk of interference in their performance and even damaging them. In such cases, if you have to use electrosurgical device, take the following actions to reduce the risk:

- Use Bipolar technique as much as possible.
- Check cables and their connections and connection of plate to the patient carefully to prevent spark due to connections weakness.
- Select the plate location such that it is close to the operation area and heart or pace marker should not be positioned between plate and operation area.
- Definitely consult with cardiologist before the operation
- Use reliable monitoring equipment and continuously pay attention to ECG signals.
- Defibrillator should be always available.

CAUTION

Do not put patient plate cables and Monopolar pen cables on the ESU. It may cause the electromagnetic interference in the device electronic circuits.

NOTICE

MEG1 needs special precautions regarding electromagnetic compatibility (EMC) and needs to be installed and put into service according to the EMC information provided in the MEG1 Service Manual and also this user manual.

Portable transmitters and RF telecommunication can affect the electrosurgical device operation.

Accessories

WARNING

Never use non-standard, poor quality, damaged and defective accessories and always make sure insulator of these devices is intact.

Do not leave the electrodes of other equipment (such as monitor) on the patient body. They can create a path for leakage current and cause burning.

It is better that whenever accessory is replaced, the proper power level is adjusted again regarding to new accessory.

Never use accessories that their cable is rotted, tear or crushed or due to pressure or being coiled is deformed and sure that their pin is not broken.

Never use accessories which could not properly connect to the device or have observable breaks, tears or other degradation signs.

**WARNING**

Using non-standard and defective accessories or using unauthorized accessories will be followed with the consequences listed below:

- Unwanted generator activation
- Generator break down
- Injury or electric shock to the patient or surgery team
- Inactivation of monitoring system of contact quality of plate to patient
- Unwanted selection or mistake in surgical modes
- Reducing or connecting and disconnecting output power
- Electric shock or muscle nerves stimulation due to electric arc between two metals.
- Electromagnetic interference in monitoring equipment (when the generator is activated)
- Excessive high frequency current leakage

Only use those instruments that can tolerate maximum output voltage (V_p) in each mode. For information regarding the maximum output voltage please refer to technical specifications chapter on page 66. In the related table maximum voltage is given as $V_{p-p} = (2 \times V_p)$. Using instrument with rated voltage less than maximum output voltage may cause damage to the patient, operator or the instrument. It's essential that rated voltage of each instrument be provided from its manufacturer factory.

It is recommended to use the accessories whose length up to 3 m.

Note that disposable accessories should not be used several times.

If you are not confident in the compatibility of your accessories, please contact Kavandish System Company or its approved representatives for their compatibility status.

Monopolar instruments must be connected to Monopolar receptacles and Bipolar instruments to Bipolar receptacle and never to be mismatched.

All accessories must be placed securely and without need to high pressure

Never use converters for connecting accessories to the generator.

Never connect two surgical devices to an output receptacle simultaneously, because this will cause that both devices be simultaneously activated and inactivated.

Always keep surgery electrodes clean. Necrotic tissue remaining on the electrodes increases the path resistance and reduces optimal performance. Also note that the electrodes can get hot at the time of device activation. Therefore, after inactivating the device, the electrodes shouldn't have any contact with patient's body.

Electrosurgical accessories should be positioned such that their unwanted contact with patient or with each other is avoided. Active electrodes that are not used should be kept separate from the patient. Also, cables connected to the surgical instruments are better to be placed in a direction that avoided contact with patient or any other conductive object so that the risk of unintended burn is reduced.

CAUTION

It's essential that placing and removing accessories connectors from the device are done slowly and gently and high pressure to cables and connectors should be avoided.

Avoid wrapping instrument cable tightly, with pressure, and also around the instrument; because this may cause cable deformation in the long run.

Footswitch

WARNING

It must be noted that footswitch should not be used in the region 25 cm from areas that are likely to leak flammable anesthetic materials. This area is known as Medical Zone which is shown in figure below.

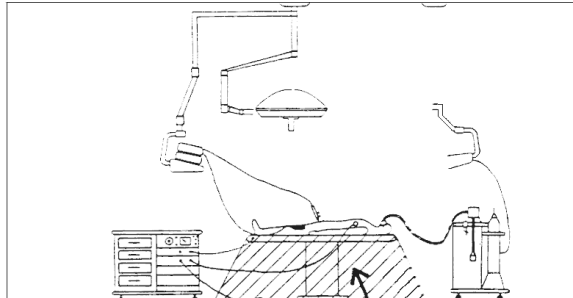

The area that only protected switches from fire hazard can be used.

Use non-flammable substances for cleaning and disinfecting footswitch.

NOTICE

Never use footswitch cable for footswitch transportation

Avoid applying pressure to the cable connection to the footswitch.

Avoid wrapping cable around footswitch firmly and with pressure.

Monopolar

WARNING

Prevent skin to skin contact (for example between arms, the patient's body or thighs). For that purpose a towel or dry gauze can be used. Also, the parts of patient's body that have excessive sweating and there is the possibility of having contact with other parts of the body, should be kept dry with a towel.

Note that if two surgeons activate Monopolar1 and Monopolar2 outputs simultaneously in Spray mode, output power is divided between the two surgical pens. So, power connection or disconnection in one Monopolar pen can affect on the other output power.

Plate

WARNING

Correct use and proper placement of plate is one of most important points in effective and safe use of Monopolar electrosurgery.

Kavandish System Company suggests using dual plates to increase patient safety. In case of single plate use, contact quality of plate with patient will not be monitored by the device.

In case of using polymer plates, definitely use silicon and standard types. Non-standard rubber plates with unknown brands can cause burn. Worn and old polymer plates will lose its quality over time

WARNING

Select kind and dimension of plate according to the table related to the minimum surface required for plate on page 32 and output power. And place the plate such that a suitable contact surface is established between itself and the patient's skin. If the effective contact surface is low due to weak and imperfect contact, it could cause burn resulting from current density increase in contact area.

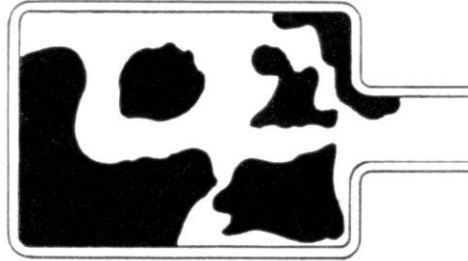

Reduction of effective plate area

□ Electrical current conductor area

■ An area that doesn't conduct electrical current since it has no contact with skin and because of being oxidized or contaminated with lipid particles has a weak conductivity.

Increase electrical conductivity of the skin of patient's body that neutral electrode is placed on it through cleaning, massaging to increase blood circulation in skin and shaving hair of contact area.

Avoid placing plate on hypodermic large blood vessels or bones or parts that blood circulation is usually weak.

In permanent plates, use proper gel uniformly on all plate surfaces. Fix plate position using rubber bands and wrapping band around it so inner surface of plate has good connection in patient skin and in case of moving the patient, check correct plate connection again.

If gel is not used, be careful that during surgery, any fluids or moisture due to bleeding, or washing or disinfectant liquids or patient's body sweat does not reach the plate. Due to penetration of those liquids to plate, may increase the possibility of burn in the area

All over the current conductive area from plate should be fixed, in an appropriate location that blood circulation in that area is normal (such as upper arm and thigh), in the closest area to the operation position. Such that direction of current flow between the plate and Monopolar active electrode be the short possible path and as much as possible does not pass through heart and lungs.

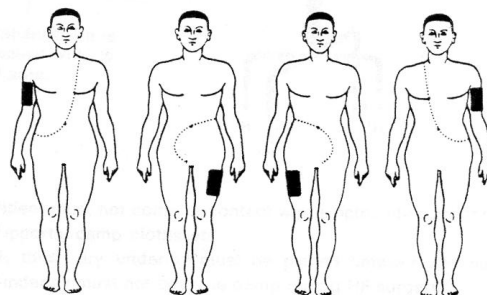

Never use water, salt water solution or wet fabric for strengthening plate to patient contact.

In case electrically conductive parts are placed inside the patient's body, choose the plate location such that those parts are not in the current path.

WARNING

Never deform patient's plate against the manufacturer's instruction and note that they're not torn or interrupted.

Always make sure that cable insulation of neutral electrode is intact.

NOTICE

It is recommended that plate position and patient's skin condition is recorded in patient document before plate placement.

Bipolar**WARNING**

Based on advantages of Bipolar technique that are expressed below; it is recommended to use Bipolar techniques in all practical possible cases which the area of current flow in body is small.

- In Bipolar technique, due to the limited area of the current effect region which is small area between the two tips of forceps, it requires lower output power, and no need for plate. Therefore it has much less burn hazards than Monopolar technique and also prevents unwanted coagulations.
- In Bipolar technique, due to smaller current flow through tissues and lower output power, possibility of electromagnetic interference in electronic devices is much less than Monopolar technique.

One of Bipolar technique problems is tissues adhesion and blood clots on the two forceps' tips. This issue sometimes causes recurrent bleeding when removing forceps from the tissue. To minimize the effects of adhesion, please consider the following:

- If the system is enabled before electrode-tissue contact, the first spark between the electrode and the tissue can cause tissue carbonization and sticking tissue to the electrode. Thus as far as possible, do not enable Bipolar generator before electrode-tissue contact. For this purpose, use Auto Start mode with or without delay.
- Keeping forceps on the tissue for a long time can cause tissue carbonization which itself causes tissue to stick to the forceps. Therefore disable the generator once the sufficient coagulation is done. And avoid continuing coagulation process without having beneficial effect (It is suggested to use Auto Stop mode).
- Always keep electrodes clean and after each use completely remove effects of tissue adhesion due to the previous coagulation.
- If dry tissues are operated under Bipolar technique, moist them with sterilized water or physiological salt solution previously.

Whenever during Bipolar surgery, the electrode sticks to the tissue, before separating the electrode from the tissue deactivate the current and wait for a few seconds so that capillaries discharge and adjacent tissues reduce the adhesion effects. In more severe cases, sterilized water or physiological salt solution can be used.

If Auto Start mode is selected, necessary precautions should be made. Since if electrode contacts with the tissue, the generator will be automatically activated.

CAUTION

CAUTION

During coagulation, electrodes surface are covered with tissue fluids. While the fluids are being dried, it can prevent full electrical current flow through the electrodes surface and the surgeon feels the output power is low. This problem will be resolved by cleaning the electrode after each coagulating.

After surgery

WARNING

Gently, open the communication cables from connectors.

Gently, separate the plate from the patient and see plate to patient contact area to investigate any possible injuries and burn.

If possible, for cleaning and disinfecting the device use non-flammable materials.

In case you have to use flammable materials for cleaning and disinfecting the device, wait a while until these materials are completely evaporated, before turning the device on.

Sometimes, other factors rather than increase of electric current density cause necrosis. It should be noted that such factors should not be mistaken with burns caused by electric current density increase that only occur at patient connection with metal objects or incomplete plate to patient connection area. One of those pseudo burns is chemical burns which caused by prolonged tissue contact with disinfectants material. Another kind of those pseudo-burns is related to tissue being under pressure during surgery. Tissue necrosis may occur in patients who undergo surgery for a long period of time (such as open heart surgery or neurosurgery) or after they stayed in ICU under anesthesia or with no movement. To prevent such necrosis, adequate care must be taken to avoid placing patient's tissues under prolonged pressure which could prevent supplying proper blood to tissues. Also despite the burn caused by electrosurgical device which shows itself immediately or one hour after surgery, the signs of those pseudo-burns may show themselves hours or even days after surgery.

NOTICE

Penetration of liquids into the device can cause damage to it; Since there is the possibility of liquids penetration from its bottom side, observe necessary precautions during cleaning and disinfecting the device.

The expected service life of the device is 10 years. Do not dispose of this device in the unsorted municipal waste stream. It should be placed in separate waste collection for electrical and electronic devices. Always comply with the national regulations of the relevant country when disposing of or recycling the device or its components.

Repairing or Servicing

WARNING

Danger of electric shock: Never open the device case. Any modification or repair on device must be done by authorized service personnel from Kavandish System Company.

Chapter 3

Installation and Launching

- Before Launching
- Turning on the Device
- Contents of packaging
- Checking the Device before Using in Operating Room



Before Launching

1. After opening the device package, please check the physical condition of device and its accessories. In case of damage due to transport or any other cause, please contact Kavandish System Company and notify failure type, device serial number, and your address.
2. Place the device on a fixed flat and with no vibration surface.
3. Connect the device to electric network (200 V to 240 V or 100 V to 130 V depending on delivered system) via power cable.

WARNING

To ensure compliance with safety issues and suitable earth for the device, use earthed outlets for connecting to supply mains.

NOTICE

Selecting a suitable location for the device can prevent system damage and injury.

Turning on the Device

1. Turn on the device using the main power switch (on the back panel).

NOTICE

To avoid receiving any false errors, all accessories should be kept detached from the system at turn on time and during the self check of the device.

2. Observe and check the following when the device is turning on and during self checking (testing different parts of the device).
 - First, all segments of LCD display and 7-segments are lit up respectively.
 - Then Monopolar Cut, Monopolar Coag. and Bipolar techniques and all related modes are checked and the corresponding LED will be on. Concurrently the software version number of the device along with the date and its edition also appears on the LCD display.
 - After checking, if any technical problem is observed in the device, the error code is issued and is visible on the LCD display as shown in below figure.

<p>SELF CHECK REPORT Error Codes are: 02, 12, 22</p>
--

In such case please refer to alarm code tables on page 58, to find more information about types of error. In case the reported failures are not of concern by user then press of any button will take the system to the ready to operating mode. Obviously the modes in which failure has been reported will not operate correctly.

But if after complete checking of the device no problem is observed, and then message of “no error reported” will be display on LCD as shown on below figure.



- Then “welcome to MEG1” message will appear on the LCD as shown below.

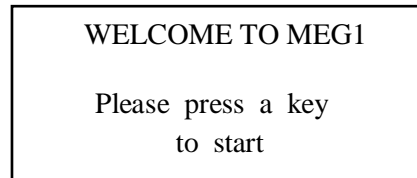

At this time the information already stored in memory number 10 (memory number 30 in Meg1-R, Meg1-E and MEG1 with bipolar TUR) appears on the panel flashing. This memory contains program which already stored in by the company as default program. In this condition press of any button will take the system to normal operating mode and is ready to work. After entering the normal operating mode, if the plate is not connected to the device “Er:PT” alarm is generated (see alarm conditions on page 55) and two subsequent sounds is generated and the indicator light turn on.

Contents of packaging

The following accessories are included in the MEG1 packaging according to the customer's order:

1. Single-use Monopolar pen
2. Single-use Dual Plate
3. Plate cable
4. Reusable Bipolar cable
5. Bipolar forceps
6. Mains power cable
7. Double pedal footswitch

Checking the Device before Using in Operating Room

If you turn on the device for the first time, before using the device in the operating room, test the performance of the device using the following instruction:

1. First, turn on the device and observe Self Checking processes according to the previous section. After entering the normal operating condition, mode adjustment and power setting must be according to default condition (memory 10). At this stage, the LCD displays the selected modes.

NOTICE

“---” condition in power displays is the sign of not selecting power in the output.

2. Carefully check all device accessories including each technique instruments, plate and footswitches, if they are ok, connect them to the device.
3. If normal single plate is connected to the device; LED indicator of single plate connection must be on. If normal dual plate is connected to the device, and if it is completely contacted



- with tissue, LED indicator of dual plate connection must be on. Otherwise, alarm LED related to lack of proper plate connection will be on and corresponding alarm will be generated.
4. For activating Monopolar, by pressing pushbutton 16, set pedal footswitch for monopolar modes, then put a piece of raw meat (or raw fruit, or a bar of soap or a piece of damp cloth) on the plate and by pressing hand switches on Monopolar instrument or corresponding footswitch, activate Monopolar Cut and Monopolar Coag techniques and apply the output to the raw meat through Monopolar instrument. Each time by activating generator, LED associated to the activated technique will be on and continuous sound of speaker will be heard. Simultaneously, information about selected technique and mode, generator activation type and alarm (if any) appears on the LCD monitor. Do this test for both Monopolar outputs.
 5. Change power levels in Monopolar Cut and Monopolar Coag. and by output activation, see the output power variation on the raw meat.
 6. In Bipolar technique, by pressing hand switch on Bipolar instrument or setting footswitch for bipolar modes (Button 16) and then using footswitch, apply the output on the raw meat through the instrument. Do this for both Bipolar Cut and Bipolar Coag techniques (by setting them through corresponding buttons) and repeat it for different power levels.
 7. Select Auto Start mode for Bipolar Coag technique and put Bipolar instrument on raw meat. In this mode Bipolar generator automatically will be activated. You can adjust delay from 0 to 2.5 seconds (see how to set delay on page 52).
 8. Now, set the generator on Bipolar Manual Coag or Bipolar Cut by using the relevant keys. In this case, the generator should not be activated automatically by placing the forceps on the meat.

Chapter 4

Monopolar Technique

- Information Regarding Monopolar in Receptacles Module Section
 - Patient Plate
 - Footswitch
 - Information Regarding Monopolar Cut in Mode and Power Setting Section
 - Monopolar Cut Modes
 - Information Regarding Monopolar Coag. in Mode and Power Setting Section
 - Monopolar Coag. Modes
 - Power Level Changes in Monopolar
 - Output Power Selection in Monopolar
 - Method of Monopolar Cut Setting
 - Method of Monopolar Coag. Setting
 - Method of Using Monopolar
-

Information Regarding Monopolar in Receptacles Module Section

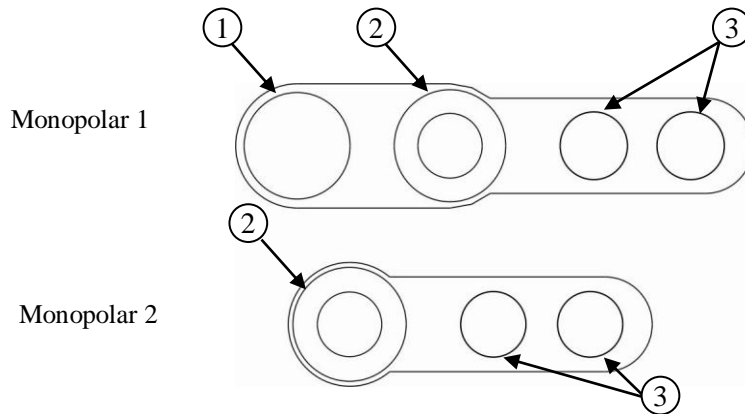

- ① 8 mm connector
- ② 4 mm coaxial connector
- ③ 4 mm normal connectors

The high frequency main current path is from 8 mm connector and core of 4mm coaxial connector. 4mm normal connectors and 4 mm coaxial connector outer shield are used for hand switch connections.

8 mm connector does not need to any adaptor because this connector is planned for the equipment such as Endoscopy, Laparoscopy or TUR units which are compatible with 8 mm diameter standard. In case that these units have been manufactured according to 4mm diameter standard, you may utilize next connector (2). In the case of using 8 mm connector, the unit will be activated only by footswitch.

Monopolar Instruments



WARNING

Kavandish System Company recommends only using Monopolar instruments within the device package which are approved by its quality control department or from the following companies: Bowa, Fiab, Martin, Tecno and Metko, Valleylab and Berchtold.

In the Meg1 product, you can use various Monopolar instruments with variety of connectors. Specifications of those connectors are presented in below table.

Table 1 Types of Monopolar Connectors

Instrument Connector	Activation Type	Monopolar connector	Description
 <p>1-pin connector with 8 mm plug</p>	Footswitch	8 mm connector	In addition to Monopolar pen, this connector can also be found on devices such as endoscopy, laparoscopy and TUR

<p>Connector with 4 mm coaxial plug (Martin type)</p> 	<p>Footswitch and hand switch</p>	<p>4 mm coaxial connector</p>	<p>--</p>
<p>1-pin connector with 4 mm normal plug</p> 	<p>Footswitch</p>	<p>Core of 4 mm coaxial connector</p>	<p>In addition to Monopolar pen, this connector can also be found on devices such as endoscopy, laparoscopy and TUR</p>
<p>3-pin connector</p> 	<p>Footswitch and hand switch</p>	<p>Core of 4 mm coaxial and 4mm normal connectors</p>	<p>--</p>

WARNING

When Monopolar is active, all output connectors of the relevant Monopolar receptacles and pens connected to these connectors have voltage. Therefore necessary precautions should be made and never connect two pens to a Monopolar connector simultaneously.

NOTICE

Use auxiliary connectors (connector number 3) just for 3-pin pens. 1-pin connector instruments should not be connected to those connectors. Such connection could damage the Monopolar receptacle.

Monopolar instrument which is connected to Monopolar2 receptacle just can be activated by hand switch and cannot be activated by footswitch.

Monopolar instruments are activated in two ways. Some instruments have hand switches which can be activated either this way or by footswitch. Other instruments don't have hand switch and can only be activated by footswitch.

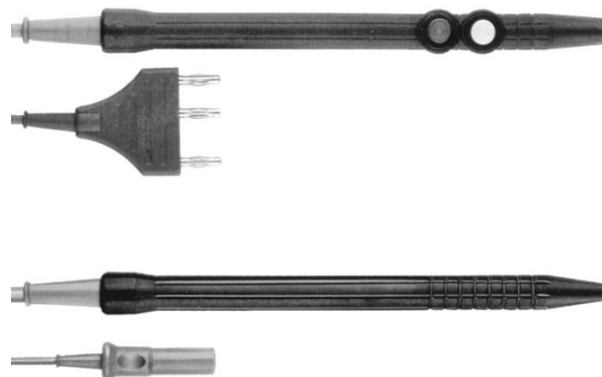

Usually, there are two push buttons on Monopolar instruments using hands witches; the surgeon selects cutting mode by pressing yellow button which is closer to the tip and coagulation mode by pressing blue button.

WARNING

Note that cables and Monopolar pens must have sufficient insulation to withstand output voltage of device (according to maximum output voltage graphs on page 66). To ensure this, it's necessary to refer to documents associated with Monopolar pen. The importance of this issue is higher in high voltage modes like spray mode; in those modes, damage or weakness of cable and pen insulation can cause unwanted effects and burn.

Monopolar cable and pen are not repairable and in case of damage a new pen must be used.

Monopolar Electrodes

Various types of electrodes of different shapes and sizes are used as an active electrode in Monopolar surgery. Those electrodes are installed on Monopolar pens. Electrode installation and replacement are easily done and the surgeon can choose their intended appropriate direction by rotating each electrode.



Some types of electrodes such as knife electrodes are provided with the device which covers common surgical uses. However, the surgeon may use other types of active electrode which can be installed on Monopolar pen depending on their needed specific mode.

Needle or lancet electrodes with small diameter are suited for smooth cuts without surface coagulation.

The use of loop electrodes is recommended for biopsy and other tissue-removal interventions. Ball or plate electrodes are used for contact coagulation.

NOTICE

To prevent electrode damage, always use appropriate boxes for storage and transportation.

Patient Plate

In Monopolar technique, the current enters the patient body through Monopolar pen electrode, and returns back to the device through plate (neutral electrode). Plates are in different types of single and dual. Those types of plates can be connected to MEG1 plate receptacle using 6.3 mm diameter connector.



WARNING

Kavandish System Company recommends only using plates within the device package which are approved by its quality control department or from the following companies: Bowa, Erbe, Fiab, Martin, and Shuyou, Valleylab, Comepa and Berchtold.

Plate Indicators on the Panel

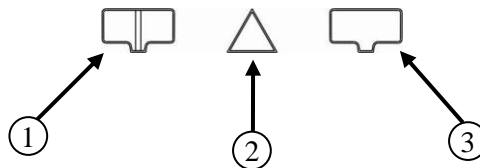

- ① Indicator of dual plate connection
- ② Indicator of plate alarms
- ③ Indicator of single plate connection

If a single plate is connected to the device, indicator of single plate connection and if a dual plate is connected to the device, indicator of dual plate connection turns on. If any alarm is detected related to plate (see alarm conditions on page 55), the indicator of plate alarms related to lack of appropriate connection turns on and the two indicators of plate connection turns off.

Patient Plate Monitoring System

Reduction of surface contact of neutral electrode or its weak connection to patient body can increase current density and thus may cause burn on contact place. This device is equipped with patient plate monitoring system and thus reduces the burns caused by inappropriate plate connection to patient body.

Patient plate monitoring system permanently (both in active and inactive state of generator) measures plate resistance with $100\text{kHz} \pm 10\text{kHz}$ frequency. Based on plate resistance, plate type and its connection quality to body are determined. Therefore, the following three cases may

occur:

- If resistance is less than 25 Ohms, it will be detected as a single plate. In this case, because of using a single plate, quality of plate connection to patient cannot be investigated.
- If resistance is between 25-150 Ohms, it will be detected as a dual plate and monitoring system is able to investigate the quality of plate connection to patient. In this case resistance changes are also calculated in addition to resistance in order to investigate changes in quality of plate connection to patient. And if the measured resistance at any time increases more than 50 percent relative to the minimum measured resistance, a poor connection quality is considered and the alarm of plate problem is generated by alarm system. Of course resistance changes are only investigated in the inactivity state of Monopolar due to because of possible impact of generator noise on plate circuits. Generator active state is short and the probability of changes in the plate connection status in short times is too small.
- If the resistance is higher than 150 Ohms, Then either the plate connection to body or device is not established, or the connection quality is low. In this case, the alarm system generates plate problem alarm.

Consequently, plate monitoring system is able to detect the inappropriateness of plate condition and automatically take the following actions:

- If the plate is not connected to the device or any damage occurs in the cable and plate connector path to the device which disconnects the connection path; appropriate alarm is generated and prevented from activation or operation continuation of the Monopolar generator.
- If dual plates are used, the appropriate plate connection to patient is investigated and if the effective contact area is not enough, the suitable alarm is generated and prevented from activation or operation continuation of the Monopolar generator.
- If dual plates are used and Monopolar generator is inactive, changes in plate connection to patient are investigated and if those changes are higher than adequate level, the suitable alarm is generated and prevented from Monopolar generator operation.

WARNING
In dual plates, its effective contact area to patient body is of great importance and if there is any problem in the quality of plate connection to patient body, the device will sense it and generates the alarm.
Using dual plates extensively reduces unwanted burns in plate location.

Material and Dimension Selection of Patient Plate

Choosing material and dimension of patient plate depends on the used output power. In the following figure the minimum required surface area for different types of plates is shown.

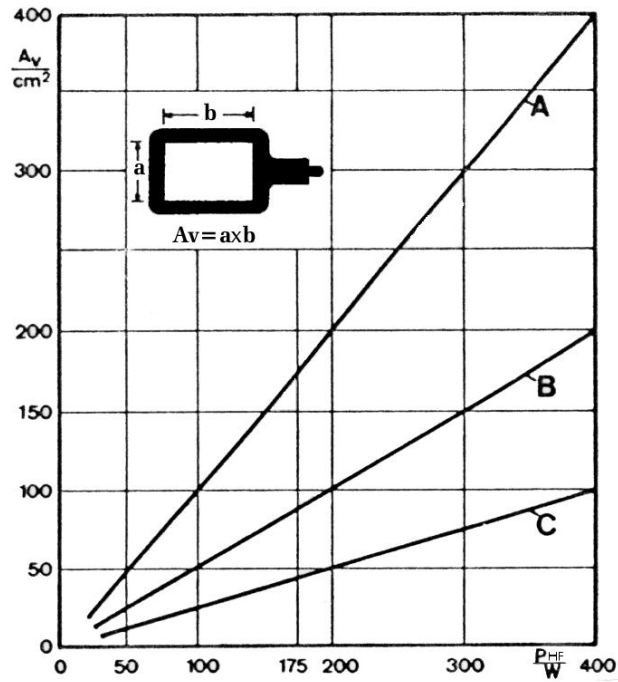

- A: patient plate is made of silicon rubber.
- B: patient plate is made of stainless steel without using electrical current conductor gels.
- C: patient plate is made of flexible metal plate with using electrical current conductor gels or disposable plates having current conductor gels or sticky gels.

WARNING

For patient safety, it is necessary to use the minimum required contact surface area for patient plate based on the maximum output power used on each patient.

Footswitch

In order to use footswitch in Monopolar technique, it is necessary to connect a two-pedal footswitch to the Monopolar footswitch receptacle on the back panel. If indicator 17 in following figure is on, by pressing the button 16, you must change the footswitch state. In this case, indicator 15 is on and by pressing yellow pedal, Monopolar Cut and by pressing blue pedal, Monopolar Coag will be activated.

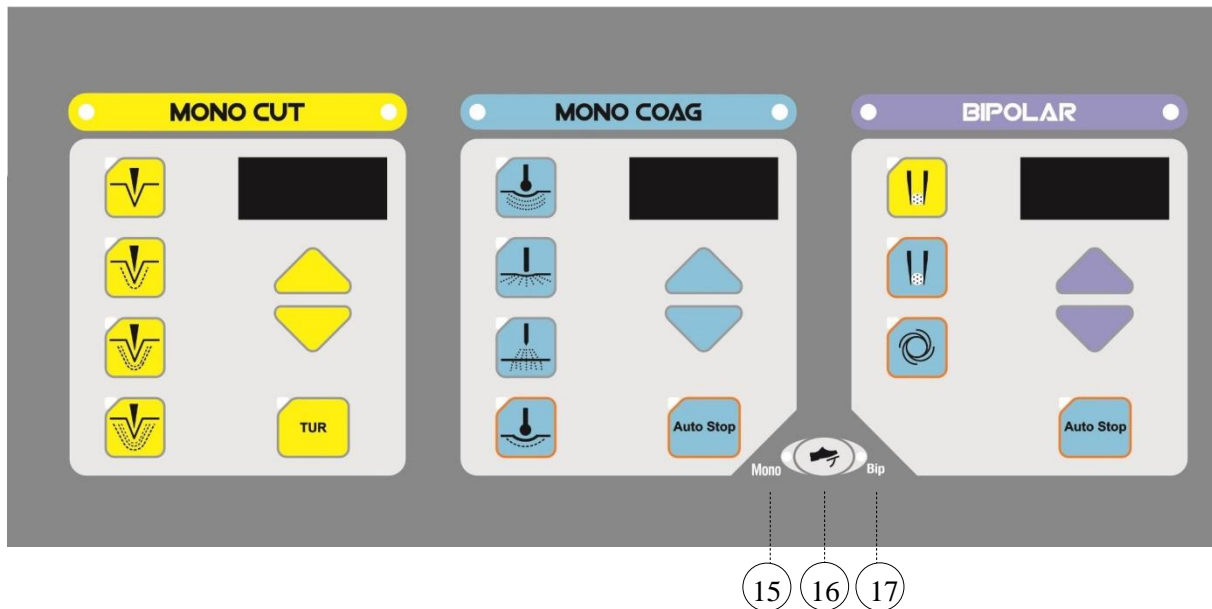

NOTICE

Whenever indicator 15 is on, pressing the footswitch just activates the monopolar output, and while indicator 17 is on, pressing the footswitch just activates the bipolar output.

The two-pedal footswitch provided with the device is as follows:



Footswitch supplied with device is designed and manufactured in accordance with international standards IEC6601-1 and IEC60601-2-2 by Kavandish system. The structure of the footswitch is protected against spillage and ingress of liquids.

WARNING

Kavandish System Company recommends only two-pedal footswitch within the device package which are approved by its quality control department.

Information Regarding Monopolar Cut in Mode and Power Setting Section

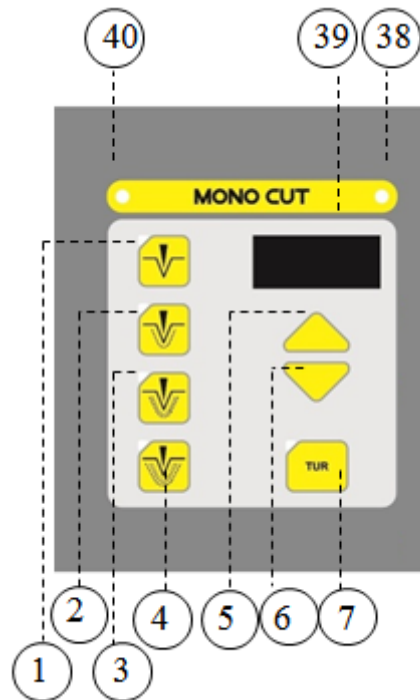

1. This pushbutton and indicator light selects pure cutting mode.
2. This pushbutton and indicator light selects Blend I.
3. This pushbutton and indicator light selects Blend II.
4. This pushbutton and indicator light selects Blend III.
5. This pushbutton increases the monopolar power output (Monopolar1, 2) in cut mode.
6. This pushbutton decreases the monopolar power output (Monopolar1, 2) in cut mode.
7. This pushbutton and indicator light selects TUR mode.
- 38, 40. These indicator lights indicate the activation of monopolar cut generator.
39. This digital display indicates the monopolar power output in cut mode.

Output power will change in certain step by each press on output power setting buttons or keeping a finger on them.

Monopolar Cut Modes

Pure: This mode provides pure and smooth cut with minimum coagulation in surrounding tissues. In this mode damage to the surrounding tissues during cutting is minimal.

Blend: In this mode in addition to cutting, the tissues adjacent to electrode will be coagulated. 3 blend degrees exist for controlling coagulation depth of adjacent tissues during cutting. By increasing the blend degree from Blend1 to Blend3, the rate of coagulation of adjacent tissues will be greater. In Blend3 tissues adjacent to cutting area will be more coagulated than other cut modes. As a result, this degree is suitable for cutting tissues with excessive bleeding and tissues with fat layers.

TUR: This mode has been prepared for surgery in fluid environments such as bladder and prostate. It will be activated along with one of the optional modes of Pure, Blend1, Blend2 and Blend3 as a complementary mode to create clinical effects of those four modes in fluid environment operation.

Information Regarding Monopolar Coag. in Mode and Power Setting Section

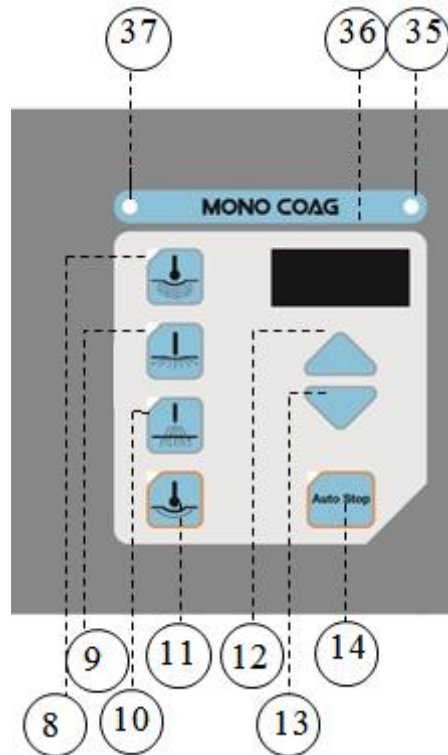

- 8. This pushbutton and indicator light selects swift coagulation mode.
- 9. This pushbutton and indicator light selects forced coagulation.
- 10. This pushbutton and indicator light selects spray coagulation or fulguration.
- 11. This pushbutton and indicator light selects soft coagulation mode.
- 12. This pushbutton increases the monopolar output power in coagulation mode.
- 13. This pushbutton decreases monopolar output power in coagulation mode.
- 14. This pushbutton and indicator light select Auto Stop mode for monopolar coagulation.
- 35, 37. These indicator lights indicate the activation of monopolar coagulation generator.
- 36. This digital display indicates monopolar output power in coagulation mode.

Output power will change in certain step by each press on output power setting buttons or keeping a finger on them.

Monopolar Coag. Modes

Swift: This mode is used for rapid coagulation of tissues using electrodes with relatively large cross section such as ball, plate electrodes or forceps (the surgeon takes the position with forceps and contacts the active electrode to it).

Forced: This mode is used for deep coagulation of tissues using electrodes with small cross section.

Spray: This mode is used for coagulation of tissues surfaces with low depth without contacting the electrode with tissue. The main feature of this mode compared to others is its more electric

arc intensity and the possibility of coagulation by the use of electric arc without direct contact of electrode with tissue. This mode is appropriate for minimizing the effects of cutting and tissue separation. If this mode is selected, the two Monopolar1 and Monopolar2 outputs can be activated simultaneously; whereas in other modes in the case of demand for activating two Monopolar outputs, priority is given to Monopolar1 and Monopolar2 will not have output.

NOTICE

Notice that when two surgeons simultaneously activate monopolar 1 and monopolar 2 outputs in spray mode, the output power will be divided between two monopolar (1, 2) pens. Consequently connecting or disconnecting the current in one of monopolar pens, may effect on the output power of the next monopolar pen.

Soft: This mode is used for soft coagulation of tissues without carbonization and adhesive effects of tissue to electrode. In this mode, the output voltage is lower than the three previous modes.

Auto Stop: If you want to stop coagulation at the time of optimum coagulation automatically in soft coag mode, you can choose Auto Stop mode. Consequently the equipment will measure electric resistance changes of the tissue which is under coagulation. When the tissue reaches to the optimum coagulation stage (before carbonizing and desiccation of the tissue), the output will be terminated automatically and related audible alarm will be sounded. Notice that you can choose this mode (Auto Stop) only in the soft mode and there will be no reaction if you press this button when you are in other modes.

Power Level Changes in Monopolar

In Meg1, Monopolar adjustable power level is divided into different ranges. Step of power level changes in various ranges is different:

- Range 1: from 0 to 50 with step1
- Range 2: from 50 to100 with step 2
- Range 3: from 105 to 200 with step 5
- Range 4: from 200 to the end with step 10

Output Power Selection in Monopolar

Selecting the appropriate output power value in Monopolar technique is one of the most important effective factors in cutting and coagulation quality. Optimal power value depends on different factors such as geometry of the used active electrode, speed of surgeon's hand, the way of electrode movement on tissue, tissue characteristics, and selected current waveform.

Although power selection completely depends on surgeon's experiences and opinion; but following considerations are recommended for appropriate power selection:

- In Pure mode, in the case of using needle or lancet electrodes which have small diameter, lower powers (100 to 150 watts) and with larger diameter electrode such as knife electrodes, higher powers (150 to 200 watts) should be used.
- In fat tissues cut, the selected power must be 20 to 50watts greater than for other tissues cut due to the increased electrical resistance of those tissues.
- Since there are layers of dried blood and tissues on surfaces of dirty electrodes, which prevents sufficient current flow, there is a need to select excessive power. To prevent using excessive power; it is necessary to keep the surface of active electrodes clean.
- Set power level for more coagulation in adjacent tissue as follows:

- Set power level at 120 to 170Watt in Blend1 mode.
- Set power level at 100 to 150Watt in Blend2 mode.
- Set power level at 50 to 100Watt in Blend3 mode.
- If you need to utilize TUR mode you will be permitted to use all various modes of Blend and pure mode .Generally suitable power in pure mode is between 150 and 200 Watt, in Blend 1 mode is between 120 and 170 Watt, in Blend 2 mode is between 100 and 150 Watt, and in Blend 3 mode is between 70 and 120 Watt.
- It is recommended that swift coagulation utilize and 50 to 100Watt output power set when ball, plate electrode or forceps is utilized.
- Utilize forced coagulation and set output power between 30 and 70Watt in the event of choosing the active electrodes their efficient surface is relatively small.
- Set output power between 20 and 50Watt in spray coagulation mode if you use the electrode with thin diameter.
- Select the soft coagulation to minimize tissue carbonization. Mostly suitable power in this mode is between 40 and 80Watt.

NOTICE

Remember that, selecting power rate more than the required rate can cause an increase of probable dangers and side effects.

Method of Monopolar Cut Setting

1. For setting Monopolar Cut technique on each of Pure, Blend1, Blend2, Blend3 or TUR modes, press the corresponding button until its LED indicator is on.
2. If TUR mode is selected, for complementary modes among Pure, Blend1, Blend2 and Blend3, press the corresponding button until its LED indicator is on.
3. Power value of the current mode is displayed in Monopolar Cut power display. Press the power set buttons to change the value. Power value will change one unit by each time you press on the buttons. To speed up power value change, keep your finger on the button.

Method of Monopolar Coag. Setting

1. For setting Monopolar Coag. technique on each of Swift, Forced, Spray and Soft modes, press the corresponding button, until its LED indicator is on.
2. Power value of the current mode is displayed in Monopolar Coag. power display. Press the power set buttons to change the value. Power value will change one unit by each time you press on the buttons. To speed up power value change, keep your finger on the button.

Method of Using Monopolar

1. Connect the desired plate to the plate receptacle (on the front panel).
2. Connect the desired surgical instruments to the Monopolar receptacle (on the front panel).
3. If footswitches is used, connect footswitch to Monopolar footswitch receptacle (on the back panel).
4. In order to use footswitch in Monopolar technique, if indicator 17 is on, by pressing the button 16, you must change the footswitch state. In this case, indicator 15 is on and by pressing pedal, only Monopolar output will be activated. Whenever indicator 15 is on, pressing the footswitch just activates the monopolar output, and while indicator 17 is on, pressing the footswitch just activates the bipolar output and does not effect on monopolar output.
5. Perform Monopolar setting in the related section (see the previous two section).
6. Place the surgical instrument on the tissue.
7. Press yellow hand switch or footswitch for Monopolar Cut activation and blue hand switch or footswitch for Monopolar Coag. activation. By Monopolar activation, LED indicator of Monopolar generator activation (related to the Monopolar Cut or Monopolar Coag.) will be on and continuous speaker sound is heard. To proceed with cut or coagulation keep the generator active.
8. Stop generator activation after the desired cutting or coagulation by removing the pressure on hand switch or footswitch.

Chapter 5

Bipolar Technique

- Information Regarding Bipolar in Receptacles Module Section
 - Footswitch
 - Information Regarding Bipolar in Mode and Power Setting Section
 - Bipolar Modes
 - Power Level Changes in Bipolar
 - Output Power Selection in Bipolar
 - Method of Bipolar Setting
 - Method of Using Bipolar
-

Information Regarding Bipolar Receptacle and its Accessories

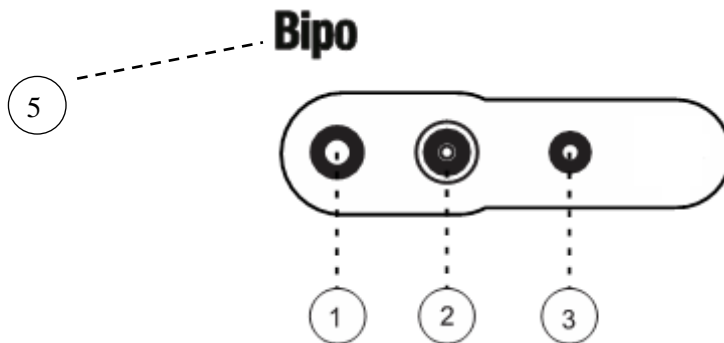

- 1 and 3. For connecting bipolar cable with 4 mm normal connectors which have 28.5 mm distance from each other.
- 2. For connecting bipolar cable with 2 mm coaxial connector
- 5. Indicator of Bipolar generator activation

The high frequency main current path is from 4 mm normal connectors and 2 mm coaxial connector.



Bipolar Instruments

WARNING

Kavandish System Company recommends only using Bipolar instruments within the device package which are approved by its quality control department or from the following companies: Bowa, Fiab, Martin, Tecno, Metko, valleylab and Berchtold.

In the Maeg1 device, there is the possibility of using various Bipolar instruments having a variety of connectors. Specifications of those connectors are presented in below table.

Table 2 Types of Bipolar Connectors

Instrument connector	Activation type	MEG1 Bipolar connector
2-pin connector 	Footswitch	4 mm normal connectors
Twin connector 	Footswitch	4 mm normal connectors



<p>Connector with 2mm coaxial plug (Martin type)</p> 	Footswitch	2 mm coaxial connector
--	------------	------------------------

Bipolar Coag. Forceps

There are a variety of Bipolar forceps with various shapes and sizes which can be used for tissue coagulation.



In Bipolar forceps, except the two ends of forceps, the rest of areas are covered with insulating material. Thus, coagulation doesn't occur in other areas except the forceps tips when contacting with the tissue. Also it will not cause surgeon's hand irritation when Bipolar output is activated.

Notice

Do not tightly press forceps or open its tips, because it will damage the coating of forceps insulation

Bipolar Cut Scissors



In addition to scissors, some other instruments are used for Bipolar Cut. Those instruments are used in special surgeries. An example of such instruments is shown in the following figure. In this instrument, one of the polar is a thin needle-shape electrode, which is suitable for tissue cut and the other polar is a metal cover to provide the returning current path.

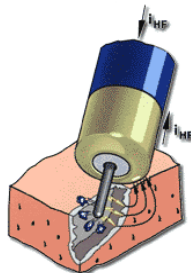

Footswitch

In order to use footswitch in bipolar technique, it is necessary to connect a two-pedal footswitch to the Monopolar footswitch receptacle on the back panel. If indicator 15 in following figure is on, by pressing the button 16, you must change the footswitch state. In this case, indicator 17 is on and by pressing yellow pedal, Bipolar Cut and by pressing blue pedal, Bipolar Coag. will be activated.

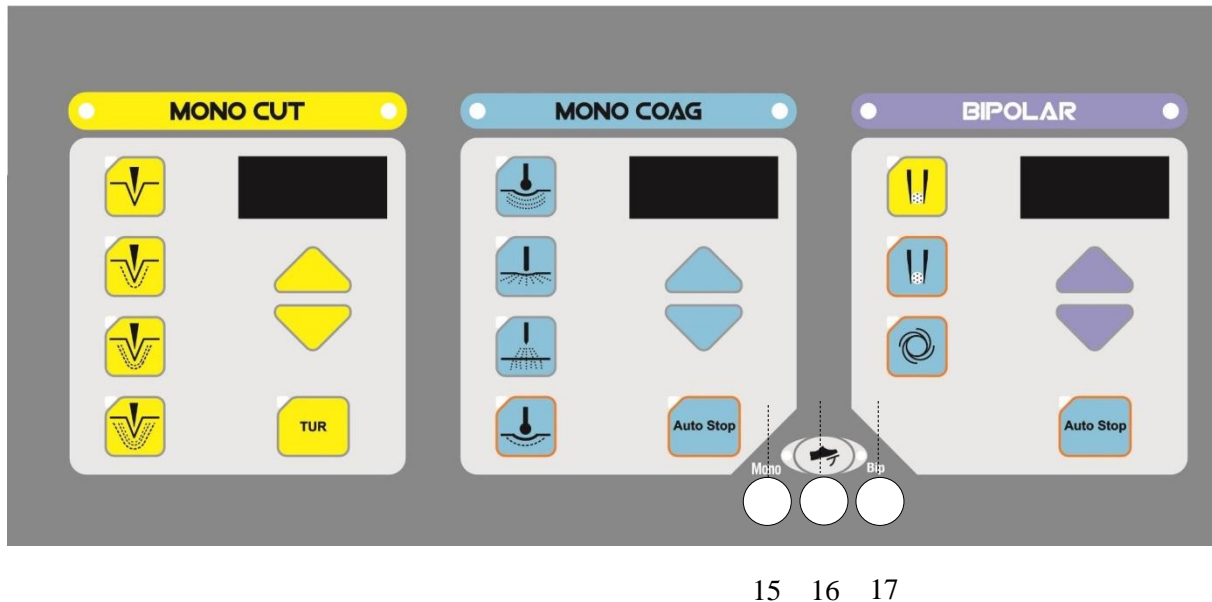

NOTICE

Whenever indicator 15 is on, pressing the footswitch just activates the monopolar output, and while indicator 17 is on, pressing the footswitch just activates the bipolar output.

The two-pedal footswitch provided with the device is as follows:



WARNING

Kavandish System Company recommends only using footswitch within the device package which are approved by its quality control department.

Information Regarding Bipolar in Mode and Power Setting Section

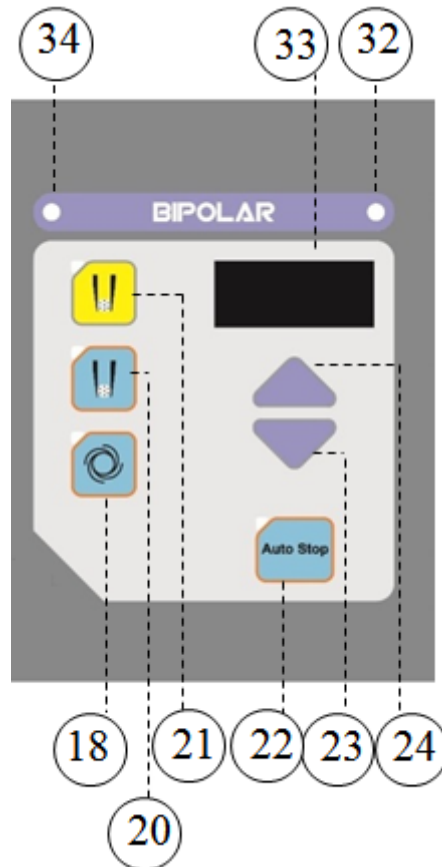

18. This pushbutton and indicator light selects auto-start mode with programmable delay. if footswitch has been selected for Bipolar, The Auto Start mode Will Change to manual mode by pressing the footswitch.

Auto Start Bipolar coagulation: The bipolar output is activated after the two tips of forceps touch the tissue. It is impossible to activate the bipolar output automatically whenever monopolar output is activated.

20. This indicator light selects manual Bipolar Coagulation.
Bipolar output is activated only by pressing footswitch.

21. This indicator light selects manual Bipolar Cutting.
Bipolar output is activated only by pressing footswitch.

22. This pushbutton and indicator light selects Auto Stop mode for Bipolar coagulation.
If you want to stop coagulation at the time of optimum coagulation automatically in Bipolar Coag mode, you can choose Auto Stop mode (the other explanations is similar to part 14). Moreover you should notice that Auto Stop mode is always inactive in Bipolar cut mode, so pressing this button in this mode, do not make anything activate.

23. This pushbutton decreases Bipolar output power.
If you press buttons 23 and 24 one time or hold your finger on them, you will observe changes of the

level on digital display 33. These changes are achieved in the form of separate steps in order that selecting the levels can be fulfilled more accurately.

Notice that from 0.1 to 1.0 level, the rate of level will change 0.1 step by 0.1 step, from 1.0 to 5.0 level it will change 0.2 by 0.2 step, from 5 to 10 level it will change 0.5 by 0.5 steps, from 10 to 20 level it will change step by step and from 20 to 100 level the changes will be two steps by two steps. Also the rate of chosen level is almost equal to output power and can be selected from the range of 0.1 w to nominal power.

24. This pushbutton increases the Bipolar output power.

32. This indicator light indicates the activation of Bipolar coagulation generator.

33. This digital display indicates the Bipolar output power.

34. This indicator light indicates the activation of Bipolar cutting.

Output power will change in certain step by each press on output power setting buttons or keeping a finger on them.

Bipolar Modes

Bipolar Cut: This mode is used for tissue cutting by special designed instruments for bipolar cutting. Also, this mode is used for bipolar cutting in normal saline (bipolar TUR). The power of bipolar cut mode can be rise to 300 watts. Often in bipolar TUR surgery, the power is used is more than 100 watts.

Bipolar Coag.: Bipolar Coag. mode provides soft tissue coagulation without carbonization and tissue adhesive effect to electrode. In MEG1, the possibility of selecting of Auto Start and Auto Stop are provided for this technique.

Auto Start: In this mode the possibility of automatically activating generator in Bipolar Coag. has been provided. If Auto Start is activated, generator will automatically be activated with a certain delay after sensing the tissue (contacting two tips of forceps with tissue). The delay value can be set from 0 to 2.5 seconds with 0.1 second intervals. Delay setting can be done by LCD display by four-key keypad under LCD. To learn how to set delay in Auto Start of Bipolar Coag. mode please refer to page 52.

It should be mentioned that if the corresponding hand switch or footswitch are pressed; Bipolar Coag. will immediately be out of Auto Start mode.

Auto Stop: In this mode, automatic detection of optimal tissue coagulation is provided. In surgery, interval time between optimal coagulation and start of tissue carbonization is about few tenths of a second which makes the coagulation process control difficult by the surgeon. In case Auto Stop is activated, the generator is automatically deactivated when achieving the optimum coagulation, therefore more accuracy and ease in process is achieved.

Power Level Changes in Bipolar

In MEG1, Bipolar adjustable power level is divided into different ranges. Step of power level changes in various ranges is different:

- Range 1: from 0 to 1 with step 0.1
- Range 2: from 1 to 5 with step 0.2



- Range 3: from 5 to 10 with step 0.5
- Range 4: from 10 to 20 with step 1
- Range 5: from 20 to 100 with step 2

Output Power Selection in Bipolar

The following considerations are recommended for selecting the suitable power;

- In Bipolar Coag., selecting excessive output power causes sticking of electrode to tissue, carbonizing of electrode surface, and preventing from current flow. If the tip of the forceps is clean and power is selected optimally, then complete coagulation is done within 1 to 5 seconds.
- Mostly suitable power in bipolar coagulation is between 25 and 50Watt.
- In the case of utilizing bipolar cutting, it is recommended to set output power rate from 50 to 100 Watt.
- In Bipolar Coag., if the power is selected less than the required value, coagulation is done very slowly.
- In Bipolar Coag., if the selected power is high, the tissue temperature rises rapidly which may lead to increased vapor pressure within the tissue and thus bursting and tearing the tissue.

NOTICE

Remember that, selecting power rate more than the required rate can cause an increase of probable dangers and side effects.

Method of Bipolar Setting

1. For setting Bipolar Cut and Bipolar Coag. techniques, press the corresponding button until the related LED indicator is on.
2. For selecting Auto Start and Auto Stop Bipolar Coag. conditions; press the corresponding buttons until its LED indicator is on.
3. If you need to set Auto Start delay value, use LCD display and four-key keypad located below LCD (To learn how to set delay in Auto Start please refer to page 52).
4. Power value of the current mode is displayed in Bipolar power display. Press the power set buttons to change the value. Power value will change one unit by each time you press on the buttons. To speed up power value change, keep your finger on the button.

Method of Using Bipolar

1. Connect the desired surgical instrument to the Bipolar receptacle (on the front panel).
2. If footswitch is used, connect the footswitch to the specific Bipolar footswitch receptacle (on the back panel).
3. In order to use footswitch in Bipolar technique, if indicator 15 is on, by pressing the button 16, you must change the footswitch state. In this case, indicator 17 is on and by pressing pedal, only Bipolar output will be activated. Whenever indicator 15 is on, pressing the footswitch just activates the monopolar output and does not effect on bipolar output.
4. Perform Bipolar setting in the related section (see the previous section).
5. Place the surgical instrument on the tissue.
6. To activate Bipolar (if one of its mode is selected), press the hand switch or footswitch (in case Auto Start has been selected, Bipolar Coag. will automatically be activated). By Bipolar activation, LED indicator of Bipolar generator activation will be on and continuous speaker sound is heard. To proceed with cut or coagulation keep the generator active.
7. Stop generator activation after the desired cutting or coagulation by removing the pressure on hand switch or footswitch (if Auto Stop has been selected, the generator will automatically detect the tissue coagulation and Bipolar Coag. is disabled. In this condition, the visual and auditory Coag Complete information signal is generated to notify the user (please refer to section information conditions on page 59).

Chapter 6

LCD Display Pages and How to Use them

- LCD Display Applications
- Settings Pages
- Programming Pages
- Display Page of Alarm Codes which are Generated while Working with the Device
- How to Set Delay Time in Auto Start of Bipolar Coag. Mode



LCD Display Applications

LCD display is used for two purposes in MEG1 device:

- Some LCD pages are only demonstrative and just provide information about device status and its performance to the user. For example:

In case the generator is not activated, LCD displays the system main program in the first row which is one of the three main General Surgery, Micro Surgery or TUR programs. In the second row, the selected mode of Monopolar Cut is displayed which is one of Pure, Blend1, Blend2 and Blend3 modes. In the third row the selected mode of Monopolar Coag. is displayed which is one of Swift, Forced, Spray and Soft modes. In the fourth row, alarms (if any) are displayed. An example of the LCD page in generator inactivation mode is shown in below figure.

GENERAL SURGERY	
CUT: Pure	
COAG: Swift	
Er: PT	Menu

However, In case of generator activation; in the first row, type of output, which is activated, from three types of Monopolar Cut, Monopolar Coag. and Bipolar Coag. techniques are displayed. In the second row, mode is displayed and in the third row the type of accessories which has been used for activation (Hand Switch or Foot Switch) is displayed. An example of such pages is shown in below figure.

MONOPOLAR COAG	
Effect: Spray	
Activation: Foot sw	

- In addition to the mentioned display options, some of supplementary settings and device programming can be performed only through LCD display and 4-key keypad below the LCD. In each LCD page, some tools have been included for settings (entering next pages, back to the previous page and option selections). Those tools are shown in the lowest row of LCD and in each page there can be up to four tools. Using application of each of those tools can be done through corresponding buttons of 4-key keypad.

The available tools for setting are as following:

Menu	Entering to main page
Next	Confirmation of option and selection of continuous path or continuation of operation on the page
↑	Direction of move upward or number increase or letter change
↓	Direction of move downward or number decrease
Back	Back to previous page selection
Set	Confirming the selection or the performed adjustment
Inc	Increasing the selected option
Dec	decreasing the selected option
Load	Loading the program
Save	Saving the program
Name	Entering to program name page

CHR Selecting the program blinking letter to change it

Settings Pages

In settings pages, general mode and delay time in Auto Start can be set.

How to Enter the Setting Pages

1. First, press the menu button to enter the main menu (main page).

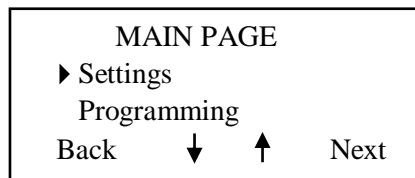

2. Select “Settings” using ↓ and ↑ tools in the main page.
3. Then enter the corresponding page by pressing Next button.

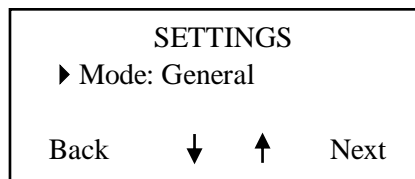

How to Select Micro Surgery, General Surgery and TUR Modes

In settings section there are three general options of Micro Surgery, General Surgery and TUR modes that can be selected.

General Surgery: This mode is selected when normal modes are desired in all techniques. In normal condition, this mode should be always selected.

Micro Surgery: When delicate surgery with low powers and high accuracy is desired, this mode is used. The maximum user-configurable power is limited in this mode.

TUR: This mode is for operation in liquid environments. This mode can be selected only by pressing TUR mode button on the front panel.

One of the known problems in TUR is cutting initiation. As the cutting electrode has a relatively large contact with the tissue and surrounding liquid, it prevents creation of high current density needed for cutting. In such situation, if generator is activated, coagulation effects are observed instead of cutting effects.

In TUR mode, appropriate high power is applied to the tissue to start cutting.

To select any of above mode, follow the below instruction:

1. First enter to the settings page.
2. Select “Mode” option by ↓ and ↑ tools in the setting page
3. Press Next button. General modes selection space is displayed.

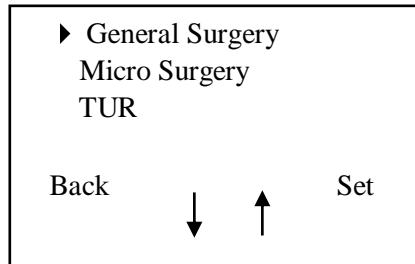

4. Select the desired general mode using ↓ and ↑ tools.
5. Then press Set button to confirm the selection. In this case LCD display the below message for a few moments. Meaning the selected option is confirmed.

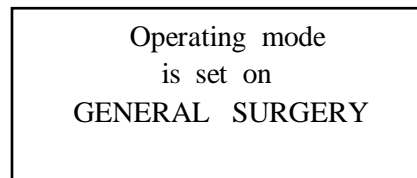

Then again, settings page will be displayed.

Programming Pages

In Meg1, the possibility of storing 10 programs (in Meg1-E, Meg1-R and Meg1 with Bipolar TUR possibility of storing 30 programs), including various modes and powers setting for different surgeries, is provided. Those predetermined settings provide the possibility of rapid changes in different surgeries. The surgeon can save desired program through LCD display and 4-key below the LCD and recall it when necessary.

How to Enter Programming Pages

1. First, press the menu button to enter the main menu (main page).
2. Select “Programming” using ↓ and ↑ tools in the main page.
3. Then pressing Next button to enter the corresponding page.

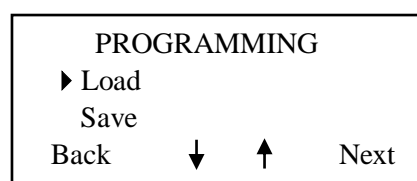
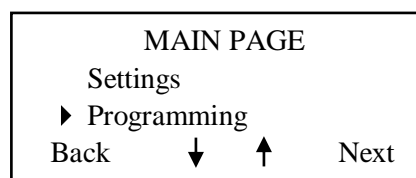

How to Recall the Preset Program in the Memory

1. First enter to the programming page.
2. Select “Load” option using ↓ and ↑ tools.
3. Press Next button to enter the load page.

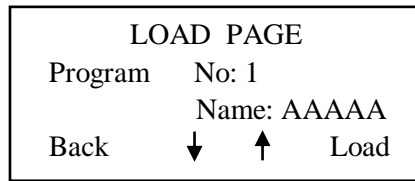

4. Select the desired program number using ↓ and ↑ tools.
5. Press the “load” button to load information of the selected memory. In this case LCD display following for a few moments as shown on below figure.

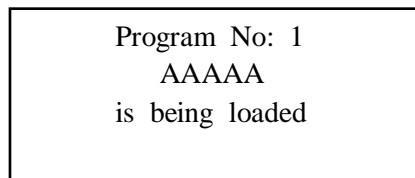

How to Save a Program

1. First enter to the programming page.
2. Select “Save” option using ↓ and ↑ tools.
3. Press Next button to enter save page.

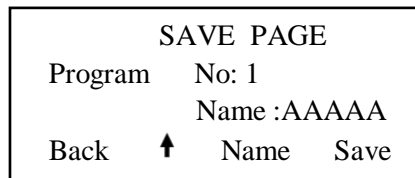

4. Select the desired number (memory number from 1 to 10) using ↑ tool.
5. To name the program, press Name button to enter the program name page. In this case, the first character of program name is blinking.

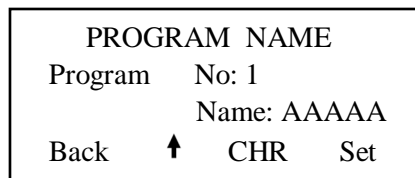

6. Select the desired character for blinking part of program name using ↓ and ↑ tools. Each character can be selected from English letters or numbers from 0 to 9.
7. Press CHR button to move to next blinking character. By each CHR press, blinking character of name is changing. Then according to the previous paragraph, select the desired character. Continue this process till the name of program is completely selected and entered.
8. Press Set button to confirm the program name. In this case, the LCD displays the following message for a few moments as shown on below figure. Then it will enter to saving page.

The Name
AAAAA
is associated to
program No 1

9. Set the desired mode and power through available controllers on the front panel.
10. Press Save button to save settings in memory. In this case, LCD displays the following message for a few moments as shown on below figure.

System settings
are being saved
into program No. 1
AAAAA

Display Page of Alarm Codes which are Generated while Working with the Device

In case some alarms generated while working with the device, the corresponding alarm code is logged in memory (please refer to alarm code tables on page 58).

How to Observe the Logged Alarm Codes

1. First, press the menu button to enter the main menu (main page).
2. Select “Errors” term in the main page using ↓ and ↑ tools.
3. Press Next button to enter the ERRORS page. The generated alarm codes while working with the device are displayed in this page.

ERRORS
22, 12
Back

Notice

In errors section, only alarm codes which are generated while working with the device are shown and errors related to self checking are not shown here.

How to Set Delay Time in Auto Start of Bipolar Coag. Mode

1. First enter to the settings page.
2. Select “Bip. time” using ↓ and ↑ tools.

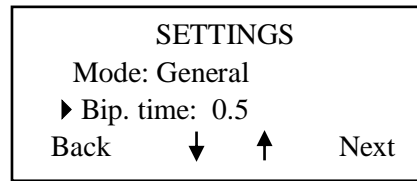

3. Press Next button to enter the delay setting space.

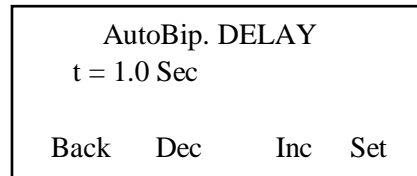

4. Set the delay time on the desired value using Inc and Dec tools.
5. Press Set button to confirm setting. In this case LCD displays the below message for a few moments. Meaning the selected option is confirmed.

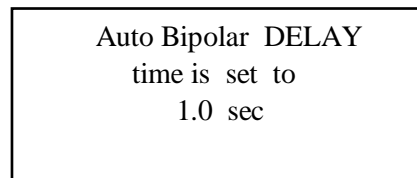

Then again, settings page will be displayed.

Chapter 7

Alarm System

- Alarm Conditions
 - Alarm Signals
 - Alarm Logging System in the Memory
 - Information Conditions
 - Information Signals Characteristics
-



Alarm Conditions

Device alarm conditions with relevant specifications are provided in the following table.

Table 3 Alarm Conditions

Event	Message on the LCD	Group	Priority	Impact on the activity	Log (in memory)
Failure in patient plate condition during Monopolar activation and or request	Fail: Plate	Technical/Functional	Medium	Deny the permission or stop of Monopolar activity	✓*
Failure in patient plate condition while no request for Monopolar activation	Er: PT	Technical/Functional	Low	--	✓*
Activation request for $p \geq 100w$ while less than 45 seconds has passed since 30 seconds activation of the system with $p \geq 100w$	Fail: P>100	Functional	Medium	Deny the permission of activity	×
Voltage increase in internal power supply more than the determined value	Fail: OV	Technical	Medium	Stop of activity	✓
Decrease in output power of HF generator below the permitted value	Er: FE	Technical	Low	--	✓
Increase of leakage current in Monopolar activation more than the permitted value	Fail: LC	Technical	Medium	Stop of activity	✓
Continuous operation of the equipment for 30 seconds	Fail: Time Out	Functional	Medium	Stop of activity	×
Continuous operation of the equipment for more than 10 seconds	Er: TO	Functional	Low	--	×
Activation request during normal start of the system, when it was in Standby or Self-Checking mode, or Setting Bipolar to Auto Start Coagulation when the electrode is on tissue	Er: IR	Technical/Functional	Low	Deny the permission of activity of the generator that caused the alarm	×
System memory failure	Er: ME	Technical	Low	--	✓
Disconnection between system internal boards during the request for system activation	Fail: Connector	Technical	Medium	Deny the permission or stop of activity	✓
Disconnection between system internal boards when no activation request presents	Er: CN	Technical	Low	--	✓

*Only in circuit failure of patient plate monitoring, this alarm is recorded in memory.

Failure in Patient Plate Condition Alarm

This alarm is generated in two conditions:

- **Plate connection failure:** This failure is occurred due to disconnection of plate connector or its cable in single plate and for dual plate is due to disconnection of plate connector or its return cable, poor quality of plate connection to the patient's body, full disconnection of plate to patient's body or large variations in resistance between the two parts of plate. Naturally, resistance variation is not checked in Monopolar activation due to possible effects of generator noise on plate circuits.
- **Circuit failure of patient plate monitoring:** This failure means that there is error in transmission circuit of dual plate connection condition to the control system. In case of such failure, the relevant alarm code is recorded in the memory. This error is only investigated when the generator is inactive phase. But subsequent to this alarm, in case of a request for activation of Monopolar technique, the equipment will not be activated and "Fail: plate" alarm is generated.

System Memory Failure Alarm

By each time writing system settings in memory, the validation of the stored values in the memory with those settings are checked, and their inequality causes "system memory failure" alarm. By any demand for system operation, "system memory failure" alarm condition ends.

Alarm Conditions Group

Based on the external cause of event and its occurrence part, alarm conditions are divided into two groups.

- **Technical**
The event occurs in the equipment or its accessories.
- **Functional**
The event happened in the interaction between equipment and operator/patient while using the equipment

An alarm may occur due to various technical or functional reasons. In Table 3 Alarm Conditions (see page 55) in front of those alarm conditions in group section, technical/ functional term has been mentioned.

Alarm Conditions Priority

Two priorities have been assigned to alarm conditions based on the amount of harm that can have for the patient, operator or the equipment. Those two priorities are called "medium" and "low" based on the IEC60601-1-8 standard.

- **Medium priority**
At the time of alarm conditions with medium priority, due to possibility of serious injury, generator activity is stopped and the equipment cannot meet the user expectation. This issue itself could have potential hazard. Thus, quick response of user is needed to fix the problem.
- **Low priority**
At the time of alarm conditions with this priority, possible damages are so mild that does not require urgent need to change the equipment operation status (such as generator inactivation). But, the user should be aware of such a condition so proper response is provided to the relevant alarm condition in appropriate time. Also, in this case that the equipment is in continuous operation, less auditory noise (due to less urgency of low priority) is generated.

Alarm Signals

By detecting of alarm conditions, visual and auditory signals (through LCD, LED, 7-segment and Buzzer) are generated in the system. All means of generating those signals are activated (by turning on the equipment). So the user can be confident of alarm system functionality. In order to perceive the visual and auditory signals by user (except LCD), maximum of 3 m distance between user and equipment is recommended. The maximum distance of 1.5 m is suitable for LCD checking.

Alarm Signals Characteristics with Medium Priority

By occurrence of an alarm with medium priority, a term associated with alarm condition which starts with “Fail:” word is displayed on the LCD. Also, ERROR LED or plate LED (based on the alarm) starts to flash in red color and auditory signal is generated according to a certain pattern by a buzzer with 79 dBA sound level (from 1m distance) and 2300 Hz frequency.

- **LEDs flashing pattern**

Continuously flashes on (600 ms) and off (250 ms).

- **Auditory signal generation pattern**

Three subsequent sounds, which is generally called burst is repeated every 4s. In each burst, buzzer is turned on and off every 250 ms.

If the medium priority alarm condition no longer exists, all generated alarm signals will cease. Only if the burst of auditory signal is not yet completed, the signal will be continued until the end of the burst.

Alarm Signals Characteristics with Low Priority

By occurrence of an alarm with low priority, a term associated with alarm condition which starts with “Er:” word is displayed on the LCD. Also, ERROR LED or plate LED (based on the alarm) is on in red color and auditory signal is generated according to a certain pattern by a buzzer with 79 dBA sound level (from 1m distance) and 2300 Hz frequency.

- **LEDs flashing pattern**

They turn on continuously

- **Auditory signal generation pattern**

Buzzer turns on and off twice continuously with 150 ms intervals.

If the low priority alarm condition no longer exists, all alarm signals will cease.

Alarm Signals Generation Ranking

With occurrence of alarm conditions with medium and low priority simultaneously, alarm signals is generated only for alarm with medium priority. Meanwhile, with occurrence of alarm with the same priority, all relevant terms are displayed on the LCD.

Alarm Logging System in the Memory

Among all alarms, only technical alarms that indicate equipment failure are stored in memory as code; so, in case it is needed, system problems can be determined. The memory has the capacity to store 10 alarms, meaning that always the information of the last 10 alarms is stored in the memory. The content of this memory does not disappear by equipment turning on/off or power disconnection.

Table 4 Table of warning concepts which have been saved by codes

code	Code concept	code	Code concept
01	Voltage increase in auto-bi-coag power-supply.	72	Output power decrease in Blend 3-cut generator.
02	Output power decrease in auto-bi-coag generator.	73	Impermissible leakage current increase in Blend 3-cut.
11	Voltage increase in bi-manual power-supply.	81	Voltage increase in swift-coag power-supply.
12	Output power decrease in bi-manual generator.	82	Output power decrease in swift-coag generator.
21	Voltage increase in bi-cut power-supply.	83	Impermissible leakage current increase in swift-coag.
22	Output power decrease in bi-cut generator.	91	Voltage increase in forced-coag power-supply.
41	Voltage increase in pure-cut power-supply.	92	Output power decrease in forced-coag generator.
42	Output power decrease in pure-cut generator.	93	Impermissible leakage current increase in forced-coag.
43	Impermissible leakage current increase in pure-cut.	A1	Voltage increase in spray-coag power-supply.
51	Voltage increase in Blend 1-cut power-supply.	A2	Output power decrease in spray-coag generator.
52	Output power decrease in Blend 1-cut generator.	A3	Impermissible leakage current increase in spray-coag.
53	Impermissible leakage current increase in Blend 1-cut.	B1	Voltage increase in soft-coag power-supply.
61	Voltage increase in Blend 2-cut power-supply.	B2	Output power decrease in soft-coag generator.
62	Output power decrease in Blend 2-cut generator.	B3	Impermissible leakage current increase in soft-coag.
63	Impermissible leakage current increase in Blend 2-cut.	F4	Failure in patient plate monitoring circuit.
71	Voltage increase in Blend 3-cut power-supply.	F5	System memory failure.
		F7	Internal system boards disconnection

Information Conditions

In addition to alarm conditions, other conditions also occur that although they are not harmless to the patient or operator, but they require user attention. Those conditions are called information condition. They include error of equipment use (when it is not harmless to the patient or operator) and new event (such as generator activation) that occurs in normal use of the equipment. The equipment information conditions with the corresponding description are given in table below.

Table 5 Information conditions

Events	Message on the LCD	Impact on activity
Generator activation	Custom page	--
Starting with zero power or decrease of power to zero value during activation	P=0	Deny the permission or stop of activity
Simultaneous activation request of Monopolar Cut and Monopolar Coag.	Unacceptable Request	Deny the permission of activity
Set the Bipolar Coagulation on Auto start when the pen is not on the tissue	Auto Bip.	--
Detecting optimum coagulation of the tissue in Auto Stop mode	Coag Complete	Stop of activity

Information Signals Characteristics

With detecting of information conditions, visual and auditory signals (through LCD, LED, 7-segment and speaker) are generated by the system.

Information signals corresponding to generator activation are different from other information conditions. The generator has a specified page on LCD which is displayed with its activation. This page includes technical information that is activated. During generator activation, LEDs corresponding to the activated technique are on and auditory signal is generated continuously by a speaker with adjustable sound level (50 dBA to 70 dBA from 1 m distance).

- **The sound frequencies generated during each technique activation**

Monopolar Cut: 680 Hz

Monopolar Coag: 520 Hz

Monopolar Coag1 and Monopolar Coag2 activation simultaneously: 470 Hz

Bipolar Cut: 610 Hz

Bipolar Coag.: 470 Hz

With occurrence of other information conditions, a term associated with it is displayed on the LCD. In some of those conditions (including P=0 and Unacceptable Request) the corresponding 7-segment also start to flash. Also, auditory signal is generated (according to a certain pattern) by the speaker with adjustable sound level (50 dBA to 70 dBA from 1m distance).

- **7-segment flashing pattern**

7-segments turn on and off with 350 ms interval.

- **Auditory signal generation pattern**

The speaker turns on and off twice consecutively with 350 ms interval.

Information Signals Rank in Comparison with Alarm Signals

In case of information and alarm conditions simultaneously, usually the message related to alarm condition(s) is displayed on the LCD (But other corresponding information and alarm signals are generated). However, LCD message related to information conditions corresponding to the user request (including P=0, Unacceptable Request, Coag Complete) as long as the request is not resolved those messages have priority to those messages related to alarm conditions.

Chapter 8

Maintenance and Repair

- Manufacture Responsibility
 - Routine Maintenance
 - Safety Checks
 - Cleaning and Disinfecting
 - After Sales Service
-

Manufacture Responsibility

Kavandish System Company can only accept the safety and device performance if below instructions are followed;

- The installation and launching of the device is done according to this User Manual.
- Device is used in accordance with the instructions of this User Manual.
- Any modifications or repairs can only be done by authorized service personnel of Kavandish System Company or its authorized representatives.

Routine Maintenance

It is recommended to check the device calibration and overall safety and performance condition of the system once a year. Therefore we suggest you to send the device to Kavandish System Company or one of its authorized representatives for calibration and safety checks and receive qualitative control results and safety standard test card along with your unit.

Safety Checks

Safety checks are performed to define whether the device's condition regarding safety and performance is in accordance with defined technical status. These checks include the following:

- Visual inspection
- Impedance between Receptacles
- Bipolar and Monopolar Output RF Leakage (according to IEC 60601-2-2)
- Line Frequency (50-60 Hz) Current Leakage (according to IEC 60601-1)
- Plate and Tissue Sensor Auxiliary Current Test (according to IEC 60601-1)
- Grounded conductor test (according to IEC 60601-1)
- Input current consumption
- Output HF Power measurements

These tests can be performed without removing the sealed enclosure of device. In case test results show any defect or failure in device performance, the device should be immediately returned to Kavandish System Company or one of its authorized representatives for examination and fixing. Do not attempt to open the enclosure or modify the device.

Cleaning and Disinfecting

Turn off the device and remove the cable from power outlet before any cleaning. Then clean all surfaces of the unit using a moistened cloth and cleanser or mild disinfectant solution.

WARNING

Use nonflammable material for cleaning and disinfecting. If you are forced to use flammable materials wait a while until those materials are completely evaporated before you turn on the device.

NOTICE

Penetration of liquids into the device can cause damage to it; since there is the possibility of liquids penetration from its bottom side, observe necessary precautions during cleaning and disinfecting the device.

Cleaning Accessories

For cleaning and disinfecting of each accessory, follow the available instructions in related packaging.

After Sales Service

One of the important feature and essential advantages of this device compare to similar ones is its fast and excellent after sales support and services.

This product is warranted for 24 months from delivery date. During this time any defect due to defective parts, workmanship or manufacturer's fault will be resolved free of charge in the company. Also the company guarantees to provide its services in terms of repair, spare part, and support for 10 years.

NOTICE

Dear customer, in case of any problem and dissatisfaction regarding our product, packaging, delivery, or recycling of the unit (after its life time) or in case of any suggestion that may help us improving our service and product quality, please contact our after sales support department in Kavandish System Company.

Chapter 9

Technical Specifications

- Dimensions and Weight
 - Input Power
 - Operating Parameters
 - Transport and Storage Parameters
 - Internal Memory
 - Displays
 - Generator Activation Tone
 - Current Consumption
 - High Frequency Leakage Current
 - Low Frequency Leakage Current
 - Patient Plate Monitoring System
 - Duty Cycle
 - Output Characteristics
 - Standards
 - Drip Proof (IEC 60601-2-2)
 - IEC Classification
 - Maximum Output Power Graphs versus Load Resistance
 - Output Power Graphs versus Adjusted Power Level
 - Maximum Output Voltage Graphs versus Adjusted Power Level
-

Dimensions and Weight

Width	37 cm
Depth	47 cm
Height	16 cm
Weight	8.8 kg

Input Power

Mains voltage	220V \pm 10% , 50HZ
Maximum power consumption	800 VA
Fuse	Standard-5*20mm 5 A - 250 V AC

Operating Parameters

Temperature	+10°C to +40°C
Relative humidity	25% to 85% (non-condensing)
Atmospheric pressure	700 mbars to 1060 mbars

Transport and Storage Parameters

Temperature	-20°C to +65°C
Relative humidity	10% to 90% (non-condensing)
Atmospheric pressure	500 mbars to 1060 mbars

Internal Memory

Storage capacity	2048 b (2 KB)
------------------	---------------

Displays

LCD	LCD display has 4 lines of 20 characters for setting modes and memories and displaying alarms and messages
7-Segment	9, 7-Segments for displaying output powers
LED	9 LED for displaying generator activation in different techniques 2 for displaying connected plate type 1 for displaying plate alarms 1 for displaying alarm existence 2 for displaying which technique is activated by pressing footswitch

Generator Activation Tone

Volume (adjustable)	50 dBA to 70 dBA (from 1 m distance)
Frequency	<ul style="list-style-type: none"> • Monopolar Cut: 680 Hz • Monopolar Coag.: 520 Hz • Mono Coag1 and Mono Coag2 (simultaneously): 470 Hz • Bipolar Cut: 610 Hz • Bipolar Coag.: 470 Hz
Duration	Continuous during generator activation

**Alarm Tone**

Volume (non-adjustable)	79 dBA (from 1 m distance)
Frequency	2300 Hz
Duration	<ul style="list-style-type: none"> • Alarm with medium priority: one burst includes 3 consecutive tones with 250 ms intervals repeated every 4 s • Alarm with low priority: 2 consecutive tone with 150 ms intervals

Current Consumption

Without R.F. power	120 mA
With maximum R.F. Power	4 A(rms)

High Frequency Leakage Current

Monopolar	Less than 150 mA
Bipolar	Less than 20 mA

Low Frequency Leakage Current

Normal condition*	Less than 10 μ A
Single fault condition*	Less than 50 μ A

* If all patient terminals are tied together

Patient Plate Monitoring System

Measurement frequency	110 kHz \pm 12 kHz
Acceptable resistance ranges	
Single plate	Less than 25 Ohms
Dual plate	25 Ohms to 150 Ohms
Alarm occurs	<p>- If the measured resistance is outside the acceptance range</p> <p>In case of dual plate connection, if the measured resistance at any time increases more than 50 percent relative to the minimum measured resistance</p>

Duty Cycle

Duty Cycle of the device, while the maximum output power in the nominal load (or a load with the resistance of less than nominal load), is utilized, has been established based on (10 s/30 s) active and inactive cycle. It means that after every 10 second operation of the unit generator, the generator should get switch off and remain 30 second in that position. In case that output power is less than maximum rate (or a load with the electric resistance of more than nominal load is utilized); it may be possible to increase the duty cycle of the unit.

Output Characteristics*

Monopolar Cut

Mode	Maximum output voltage (V _{P-P})	Maximum output current (A)	Heating Factor (A ² s)	Crest Factor**	Maximum output power (Watts)	Rated load (Ohms)
Pure	1300	1.4	58.8	1.5	360	300
Blend1	2800	13	49.2	2	330	400
Blend2	3100	1.4	55.5	2.5	300	500
Blend3	3800	1.4	55.5	2.8	270	500

Monopolar Coag.

Mode	Maximum output voltage (V _{P-P})	Maximum output current (A)	Heating Factor (A ² s)	Crest Factor**	Maximum output power (Watts)	Rated load (Ohms)
Swift	3450	1.2	45.4	3.3	200	500
Forced	3800	1.1	36.3	4.5	140	250
Spray	4500	0.9	25.4	5.5 to 7.5***	120	400
Soft	600	1.5	64.8	1.5	100	200

Bipolar

Mode	Maximum output voltage (V _{P-P})	Maximum output current (A)	Crest Factor**	Maximum output power (Watts)	Rated load (Ohms)
Bipolar Cut	900	2.6	2.5	100	75
Bipolar Coag.	550	2.4	1.5	80	75

*Nominal Frequency is 410kHz±1kHz.

**Crest Factor is a measurement of waveform which increases by increasing waveform coagulation capabilities and is calculated from the following equation:

$$C.F = V_{peak} / V_{rms}$$

***According to power adjustment

Standards

Meg1 device meets all relevant clauses of IEC 60601-1, IEC 60601-1-2 and IEC 60601-2-2 standards.

Drip Proof (IEC 60601-2-2)

MEG1 enclosure is constructed so that in case of liquid spillage in normal use, the safety and performance does not adversely affect.

IEC Classification

Protection class	I
Type of output	CF (Cardiac Floating)
Type of patient circuit	Floating Output

Maximum Output Power Graphs versus Load Resistance

In these graphs, power level is constant and load value varies. The graphs have been drawn for the two cases of maximum power and half of maximum power in each mode.

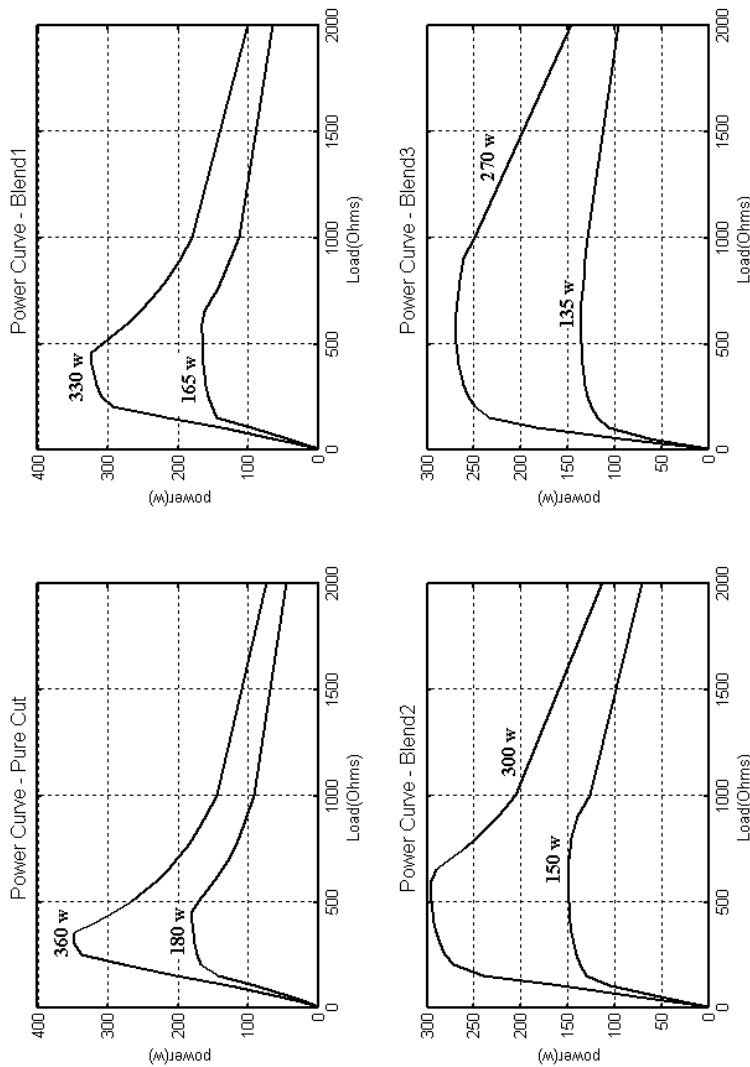

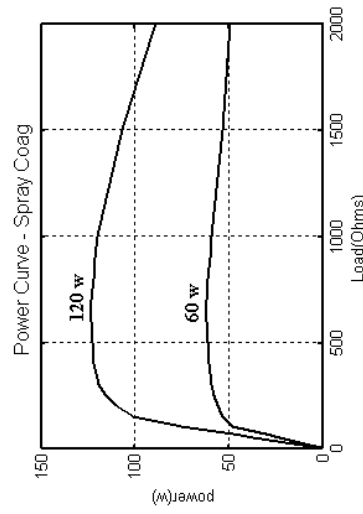
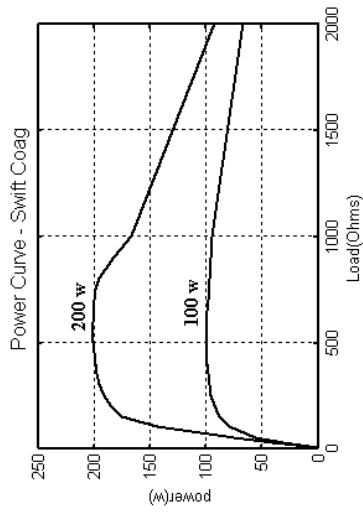
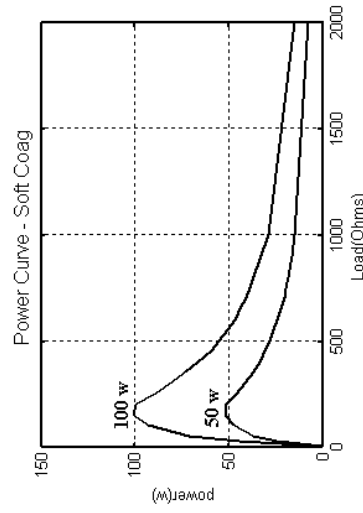
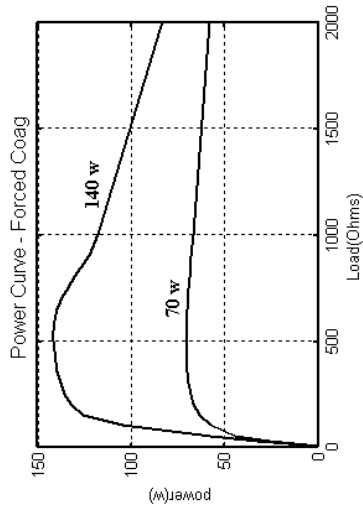

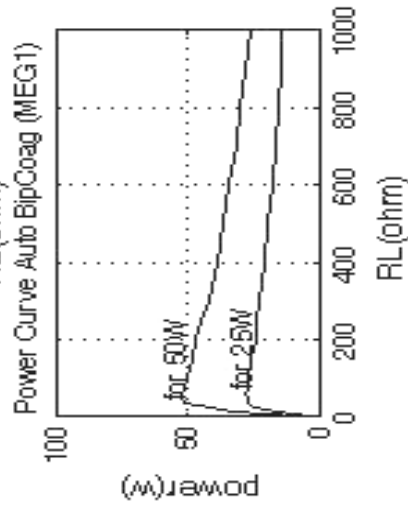
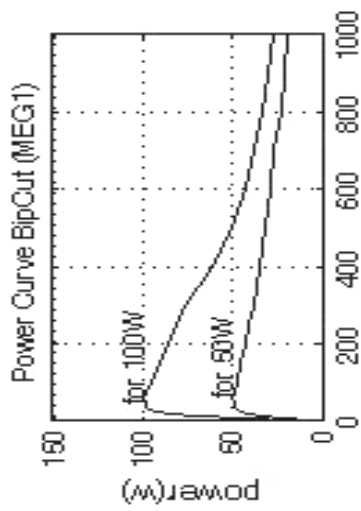
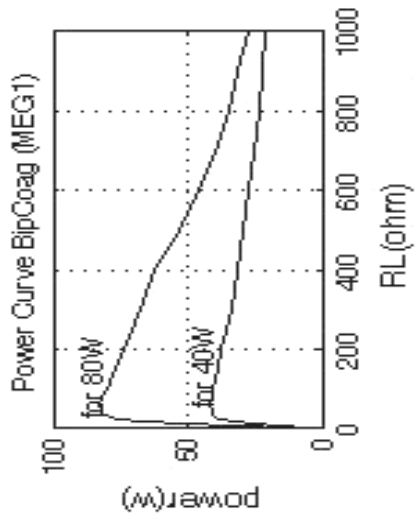

Output Power Graphs versus Adjusted Power Level

In these graphs, load is constant and power level varies from minimum to maximum.

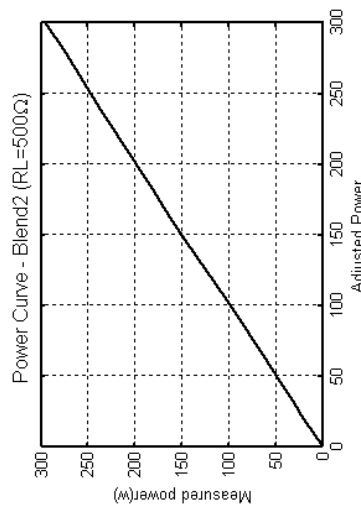
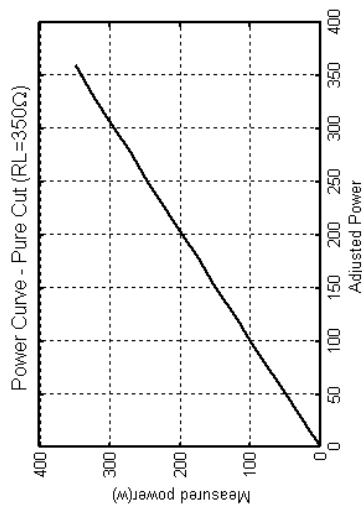
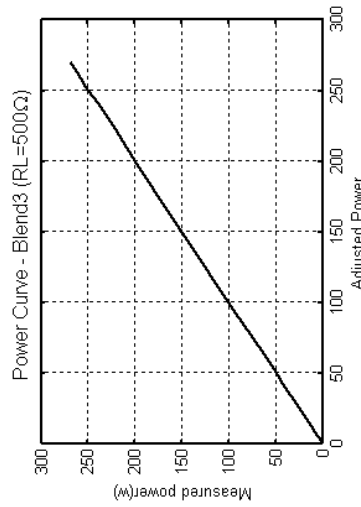
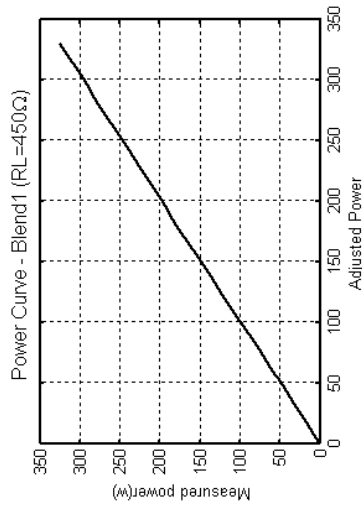

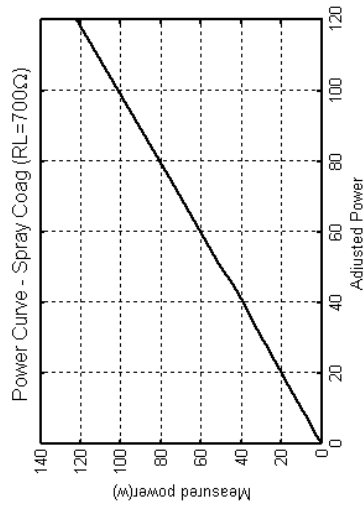
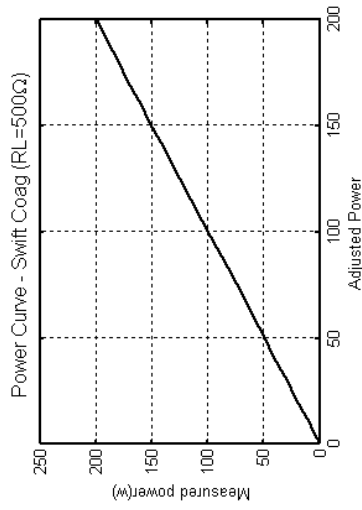
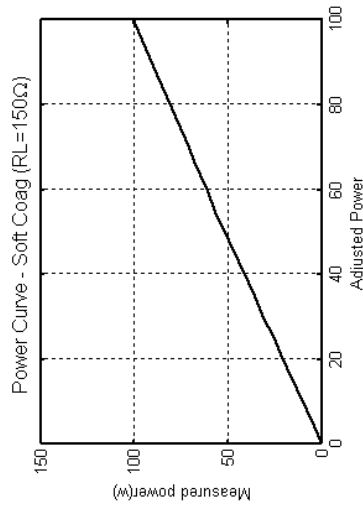
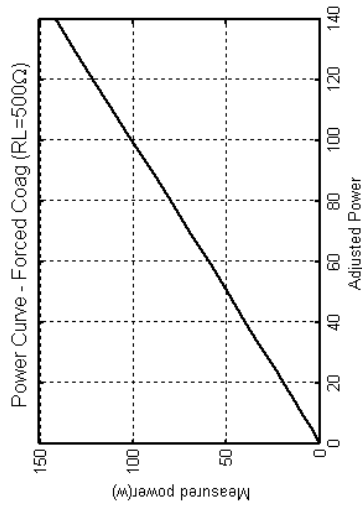

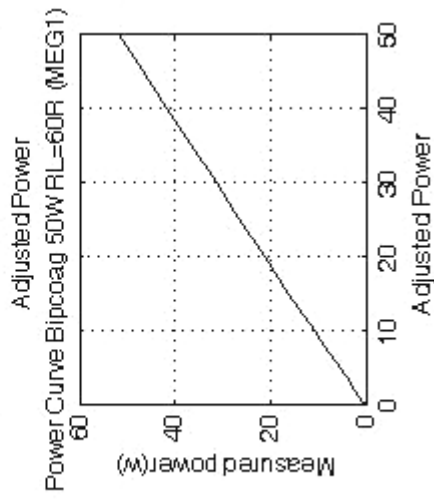
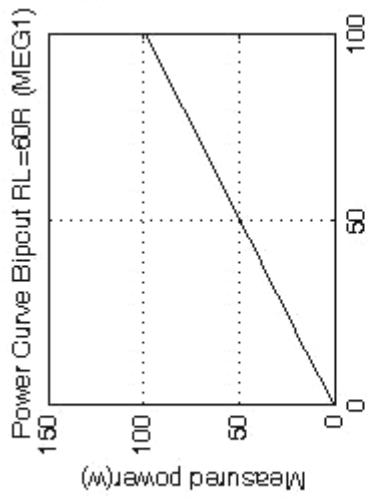
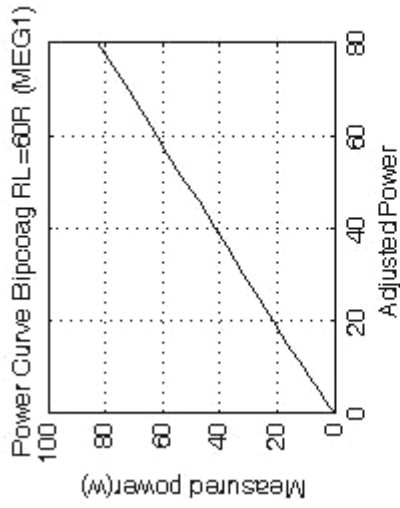

Maximum Output Voltage Graphs versus Adjusted Power Level

In these graphs, output voltages are measured in open circuit condition in different power levels.

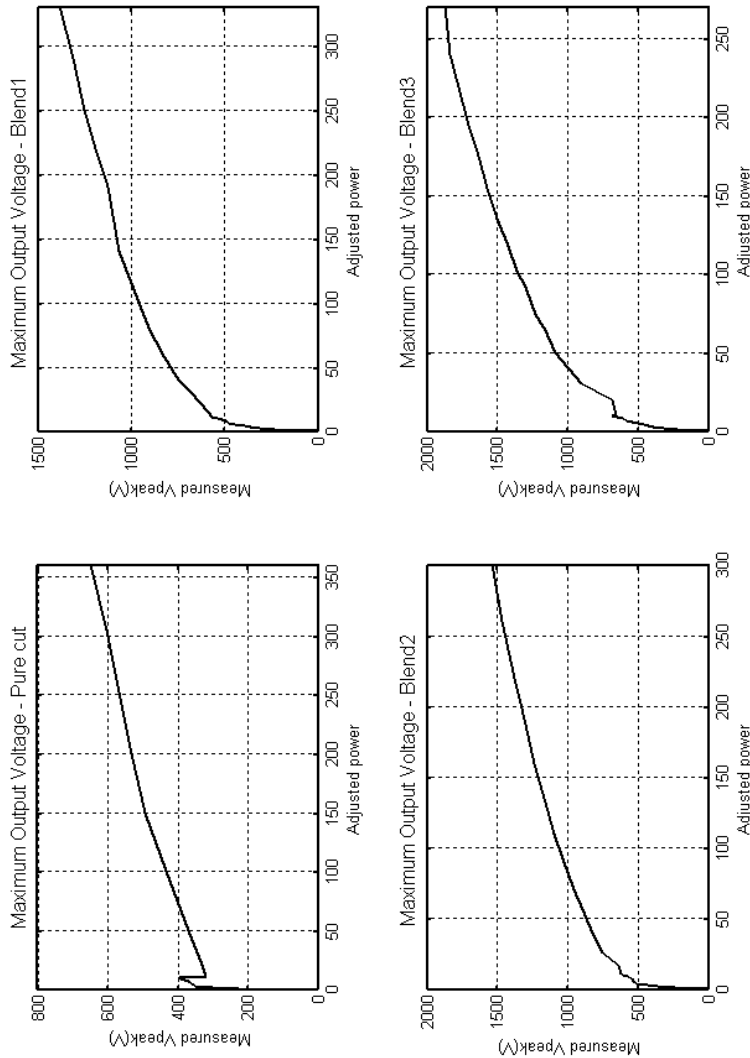

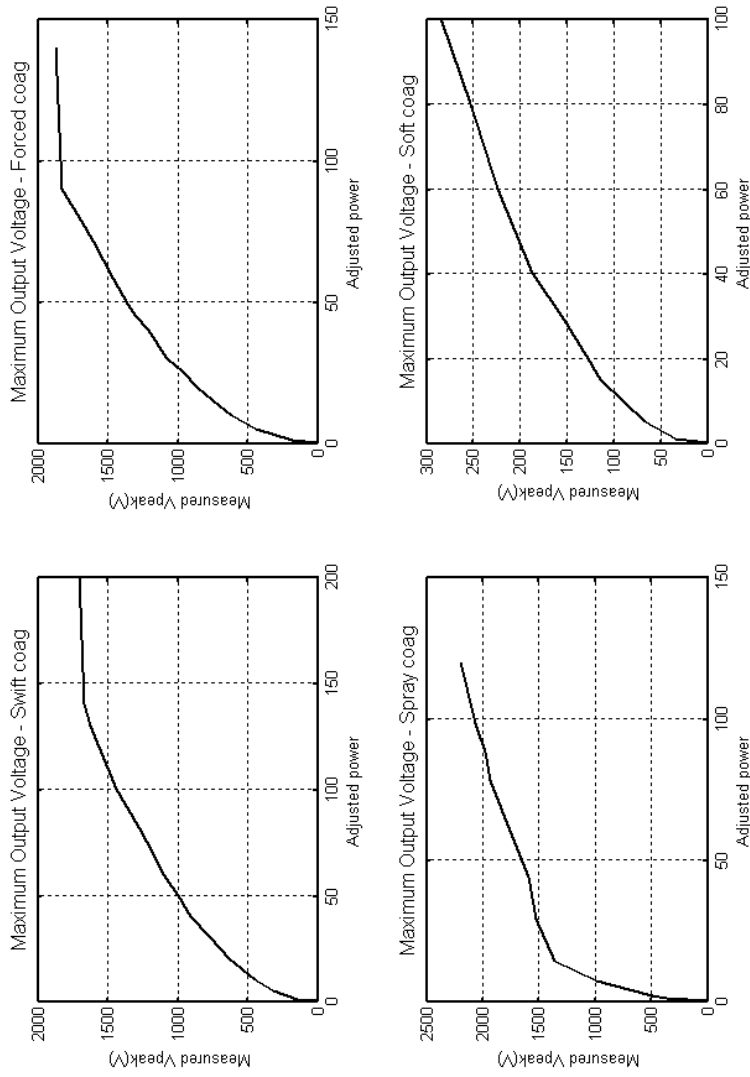

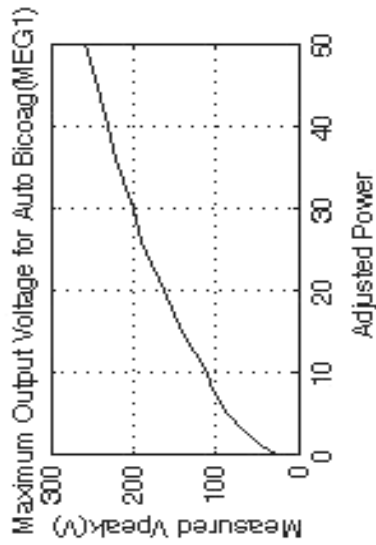
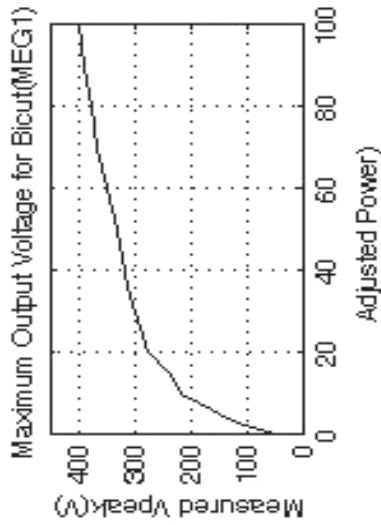
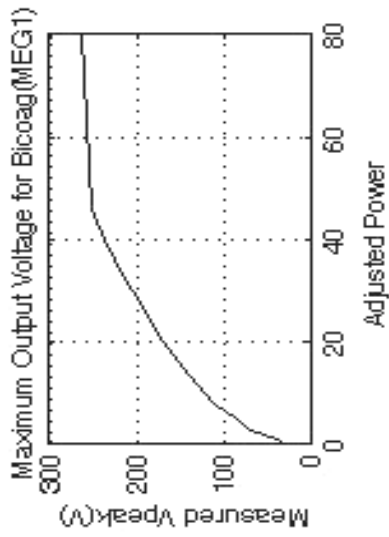

Chapter 10

EMC Compliance



Electrical Emission

The device fulfills:

CISPR 11 Class B (2009): Radiated and conducted emission

IEC 61000-3-2 (2005+ A1+A2): Harmonic current emission

IEC 61000-3-3 (2013): Voltage fluctuations and flicker

Electrical Immunity

The device fulfills:

IEC 61000-4-2 (2008): Immunity to electrostatic discharge

Test level ± 8 kV contact discharge ± 2 , ± 4 , ± 8 and ± 15 kV air discharge.

IEC 61000-4-3 (2006 + A1 + A2): Immunity to radiated electromagnetic fields in the frequency range 80 MHz – 2.7 GHz

Test levels: 3V/m with 80 % AM @ 1kHz

IEC 60601-1-2:2014: Table 9 (up to 28 V/m pulse modulation at frequencies in ISM bands)

IEC 61000-4-4 (2012): Immunity to fast transients/burst

Test levels on AC Power input port: AC input/output power input port $\pm 2,0$ kV, Signal lines: 1Kv

IEC 61000-4-5 (2006): Surge immunity test

Test levels on AC Power input port: AC Power input port, $\pm 0,5$ kV and $\pm 1,0$ kV differential mode, 2,0 kV line to ground.

IEC 61000-4-6 (2014): Immunity to conducted disturbances in the frequency range 0,15 – 80 MHz

Test levels on AC Power input port: 6 Vrms with 80 % AM @ 1KHz.

IEC 61000-4-8 (2009): Immunity to power frequency magnetic fields

Test level: 30 A/m, 50 Hz and 60 Hz

IEC 61000-4-11 (2004): Voltage Dips and Interruptions

Test levels on AC Power input port:

According to 60601-1-2, table 4-13:

95 % for $\frac{1}{2}$ cycle positive and negative half period.

95% for one period.

30 % for 25 cycles.

95 % for 5 sec.

Annex 1:

Special Features of
MEG1-E
for Endoscopy
Electrosurgical Generators

- Introduction
 - Front panel of Meg1-E
 - Back panel of Meg1-E
 - Accessories of Meg1-E
 - Cutting Modes and Power Selection
 - Coagulation Modes and Power Selection
 - Power Level Changes in Monopolar
 - EndoCut technique (Papillotomy and Polypectomy)
 - Method of Using EndoCut modes
 - Capability of Using Argon gas
 - Alarm Logging System in the Memory
 - Technical Specifications of Meg1-E
-

Introduction

MEG1-E is the specialized electrosurgical unit for endoscopic procedures.

It has been designed to perform all endoscopic cutting, standard monopolar and bipolar, coagulation and argon plasma coagulation.

Advanced endoscopic cutting modes for Polypectomy, Sphincterotomy at ERCP

Main advantages:

- Two special modes, optimized for Polypectomy and Papillotomy
- High controlled power and instant cutting initiation, reduces the risk of delayed perforation
- Limited cutting speed intelligently prevent uncontrolled rapid cutting (ZIPPER EFFECT)
- Fractionated cutting and controlled coagulation, reduces bleeding probability
- Ability of Argon Plasma Coagulation (as optional - for additional explanations refer to the capability of using argon gas on page 94 and the Argon Gas Supplier -APS1 user manual).
- 4 adjustable settings to achieve desire coagulation effect

Front panel of Meg1-E

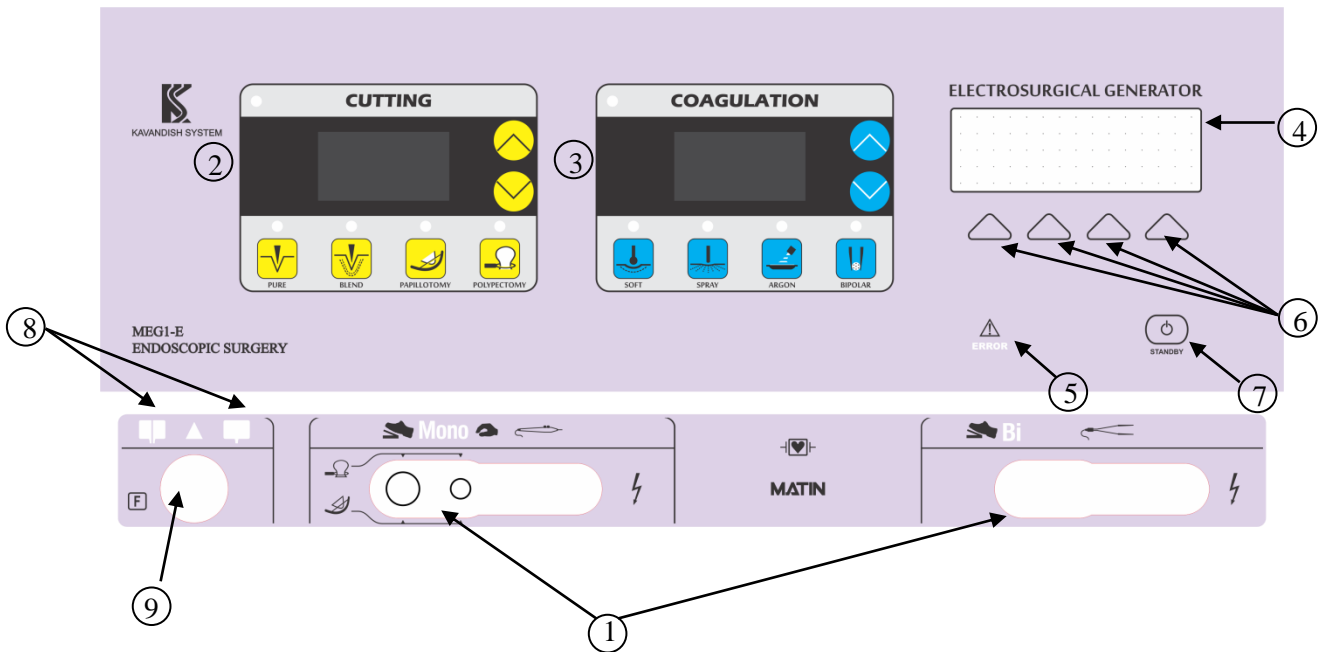

1. Device receptacles for connecting instruments
2. Display and power and mode settings of Cutting technique
3. Display and power and mode settings of Coagulation technique
4. LCD
5. Alarm indicator LED (except plate alarms)
6. Four-key keypad
7. Standby button
8. Plate connection indicator LED and related alarm
9. Dual and single pad plate receptacle

Back panel of Meg1-E

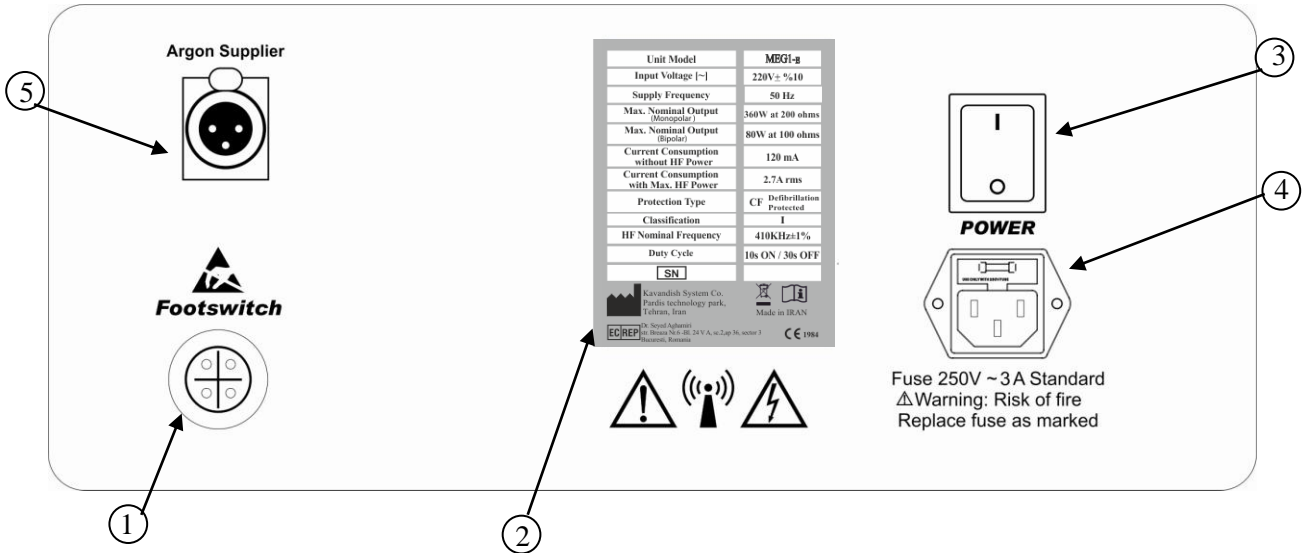

1. Double pedal footswitch receptacle
2. Device identification label
3. Main power switch
4. Line cord receptacle and Input Fuse place.
5. Argon supplier device (APS1) receptacle

Accessories of Meg1-E

The following accessories are included in the Meg1-E packaging according to the customer's order:

1. Single-use Monopolar pen
2. Single-use Dual Plate
3. Plate cable
4. Snare cable
5. Mains power cable
6. Double pedal footswitch

Cutting Modes and Power Selection

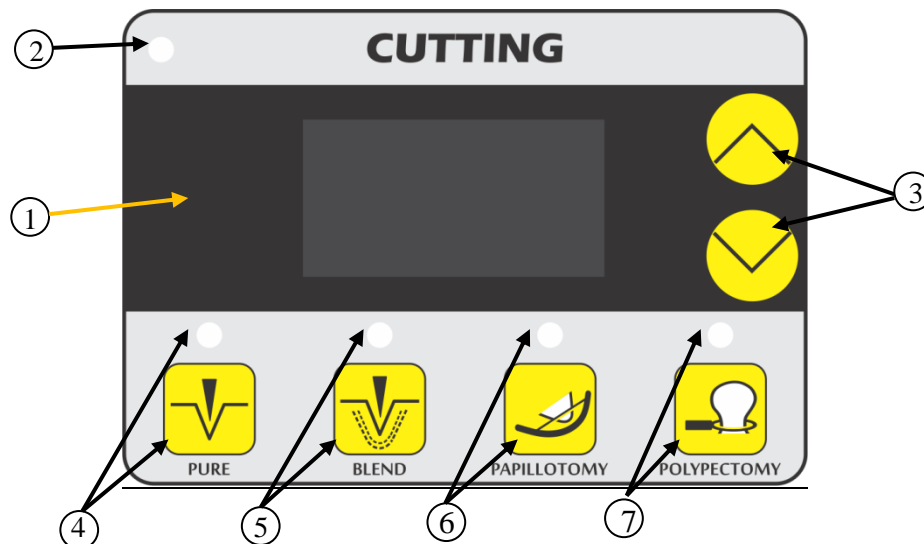

1. Display of Monopolar Cut output power
2. Indicator of Monopolar Cut activation
3. Monopolar Cut output power settings buttons
4. Button and indicator of Pure mode selection
5. Button and indicator of Blend mode selection
6. Button and indicator of Papillotomy mode selection
7. Button and indicator of Polypectomy mode selection

Cut modes

Pure: This mode provides pure and smooth cut with minimum coagulation in surrounding tissues. This mode is used if the tissue bleeding is very low.

Blend: If bleeding is seen during cutting, this mode should be used, which is a combination of cutting and coagulation mode. In this mode in addition to cutting, the adjacent tissues to electrode will be coagulated.

Papillotomy: In this mode, the device rapidly modifies current in response to changes in tissue impedance and provides a “fractionated” output to facilitate a controlled cutting process.

Tissue cutting and coagulation are performed in pulses with a specific timing according to tissue conditions. As a result, coagulation intensity and cutting speed will be under control. In addition, in this mode, the device intelligently detects start of tissue cutting and Announces an additional sound. In this way, the surgeon will get more information about the speed and amount of tissue cut. This mode is useful with needle electrodes or sphincterotomes.

Polypectomy: This mode is similar to Papillotomy, but pulse timing and some of electrical properties optimized for using with wire snares or loop electrodes in polypectomy. This mode rapidly modifies current in response to arc detection and changes in tissue impedance and provides a “fractionated” cutting. Also when cutting starts, additional sound is heard.

Coagulation Modes and Power Selection

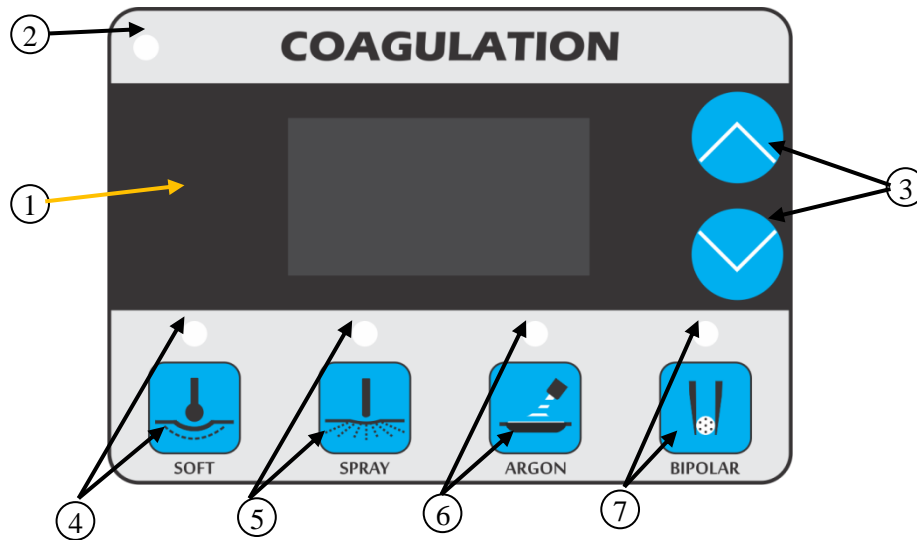

1. Display of Monopolar Coag. output power
2. Indicator of Monopolar Coag. activation
3. Monopolar Coag. output power setting buttons
4. Button and indicator of Soft mode selection
5. Button and indicator of Spray mode selection
6. Button and indicator of Argon mode selection
7. Button and indicator of Bipolar Coag. mode selection

Soft: In this mode, the electrode comes in direct contact with tissue and causes desiccation. Electrode with a wide surface area results in adequate tissue coagulation because of low current density. Unexpectedly, low voltage in this mode increases coagulation depth because in this situation it will take longer for “blanching” to occur in surface of tissue. This longer time period allows for heat to penetrate deeper in tissue. In this mode, output voltage is lower than other coagulation modes.

Spray: This mode is used for coagulation of tissues surfaces with low depth without contacting the electrode with tissue. The main feature of this mode compared to others is its more electric arc intensity and the possibility of coagulation by the use of electric arc without direct contact of electrode with tissue. This mode is appropriate for minimizing the effects of cutting and tissue separation.

Argon: In this mode, the electric current is applied to tissue in form of pulses along with Argon gas. In this mode compared to other coag modes, the energy applied to tissue is reduced and creates lower coagulation (this mode is optional in Meg1-E). Therefore, tissue destruction (creating hole or tear in thin tissues) is minimized. In maximum power, electric current is no longer pulsed and changes to continuous. It is recommended to use higher output power levels of this mode for open surgeries.

Bipolar: Bipolar Coag mode is the same as Manual Bipolar Coag. It provides soft tissue coagulation without carbonization and tissue adhesive effect to electrode. This is the only Bipolar mode presented in Meg1-E model. In Meg1-E, this technique can only be activated by footswitch.

Power Level Changes in Monopolar

In Meg1-E, Monopolar adjustable power level is divided into different ranges. Step of power level changes in various ranges is different:

- Range 1: from 0 to 50 with step1
- Range 2: from 50 to100 with step 2
- Range 3: from 105 to 200 with step 5
- Range 4: from 200 to the end with step 10

ENDO-CUT technique (Papillotomy and Polypectomy)

Polypectomy and Papillotomy (sphincterotomy) can be mentioned among the most important therapeutic procedures in endoscopy.

Endoscopists are usually worried about the risk of perforation specially when it comes to organs with thin walls (Duodenum, caecum or right colon).

Perforations are almost always attributable to excessive gastrointestinal wall coagulation. Using EndoCut, High controlled power and instant cutting initiation, reduces the risk of delayed perforation which is related to extra coagulation.

In EndoCut, electrosurgical generator continuously alternates between Cutting and Coagulation cycles. According to the tissue state, the device, intelligently adjusts duration of cutting cycles. Consequently the cutting speed is limited and uncontrolled rapid cutting (ZIPPER EFFECT) is prevented.

Less Bleeding

In Polypectomy, bleeding usually results from unduly rapid cutting and inadequate coagulation effect. But Now with **EndoCut**, by monitoring tissue situation, applying fractionated cutting and delivering proper energy in coagulation cycles, the cutting speed and coagulation intensity is completely under control.

Technical features of ENDO-CUT modes

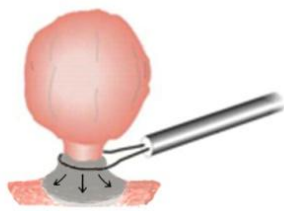

Technically, Endocut has a pulse function and includes two different phases over time: cutting phase (Cut) and coagulation phase (Coag). When the device starts working, the output waveform of the device alternately changes between the cutting phase and the coagulation phase. Thus, by controlling the time of the cutting phase, the cutting speed is adjusted and by adjusting the output voltage and waveform in the coagulation phase, the coagulation intensity will be under the control of the surgeon.

Entering the cutting phase does not necessarily mean cutting the tissue, but the environmental conditions such as the tissue impedance, the contact surface of the tissue with the snare, the accumulation of liquids around the snare, etc. affect on tissue cutting.





Main Benefits of ENDO-CUT modes

- 1- 4 adjustable settings to achieve desired coagulation effect considering the possibility and severity of bleeding
- 2- Two special modes, optimized for Polypectomy and Papillotomy
- 3- High controlled power and instant cutting initiation, reduces the risk of excessive coagulation and delayed perforation
- 4- Limited cutting speed intelligently prevents uncontrolled rapid cutting (ZIPPER EFFECT)
- 5- Accurate information about the time of cutting by hearing an audio alarm simultaneously with

tissue cutting and increase safety.

The setting of ENDO-CUT modes

In Meg1-E, Papillotomy mode and Polypectomy mode were designed and optimized for using in various surgeries.

		<p>In Polypectomy, snare or loop wire electrode are used.</p>
		<p>In Papillotomy, sphincterotomes and needle electrode are used.</p>

Information Regarding EndoCut Modes setting and related receptacles

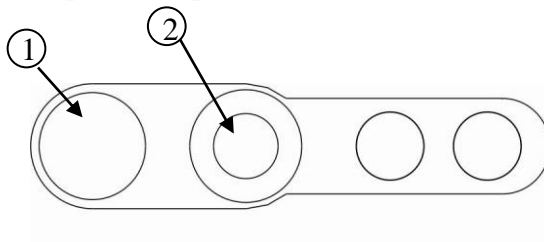

Monopolar receptacle



1. Only for 8mm connectors
2. Only for 4 mm connector

As Endoscopic instruments are usually single pin, they can only be activated by footswitch. Connect them to 8mm or 4mm female jack on monopolar receptacle.

Further explanation is given in bellow table:

No.	Instrument's connector	Activation method	Connecting pin to device
1	8mm single pin connector 	Footswitch	8 mm female jack (No.1)
2	4mm single pin connector 	Footswitch	4 mm female jack (No.2)

Warning

In Endo-cut, if instrument has usual 4mm single pin connector (No. 2 in above table), due to protect ESU, the instrument shall connect to jack No.2 on the device (above figure) and should not be connected to the next auxiliary jacks. Connecting instrument to other jacks may damage the device.

Important points when using ENDO-CUT

1. The thinner the diameter of the electrode wire, more cut and less coagulation.
2. If the polyp is on tissue with thin wall, the risk of perforation is higher and less coagulation level should be used.
3. If the pedal is released immediately and not kept long enough, the device will not enter the coagulation phase and the possibility of bleeding will increase.
4. Do not pull the snare. Pulling the Snare to achieve faster cut increases the likelihood of bleeding.
5. Closing the snare with excessive force causes the snare dipping into the tissue, increasing the contact surface of the snare and decreasing the current density. In such conditions, the onset of tissue cut may be delayed and excessive coagulation may occur. Excessive coagulation increases the likelihood of perforation. Try to close the snare with a normal force.
6. To prevent problems caused by excessive contact surface between sphincterotome and tissue, insert only one-third of front of the cut wire into the papilla.
7. Before activating the device, make sure that there are no internal gases in the body, especially in case of intestinal obstruction. Extract the flammable endogenous gases in the gastrointestinal tract before performing electrosurgery or irrigate with co₂.

Coagulation intensity in ENDO-CUT

There are 4 adjustable levels in each ENDO-CUT mode. Increasing the level does not have a significant effect on cut speed, but mainly increases coagulation degree.

. The higher the level selected, the higher the coagulation intensity. Therefore, it is recommended to use the higher level when there is a high risk of bleeding. Note, that more coagulation also increases the likelihood of perforation.

Due to the greater coagulation depth at higher levels, it is recommended to use lower levels specially where the tissue wall is thin.

Steps for coagulation intensity are the same in both ENDO-CUT modes:

- Level 1: L1 (with very low coagulation)
- Level 2: L2 (low coagulation)
- Level 3: L3 (medium coagulation)
- Level 4: L4 (high coagulation)

How to use ENDO-CUT

- 1- Connect the plate to the device.
- 2- Connect the desired surgical instrument to the Monopolar receptacle on the panel.
- 3- Connect the footswitch to the footswitch connector (on the back panel).
- 4- Select ENDO-CUT mode and adjust coagulation level.
- 5- Check the instrument on wet gauze before inserting into the endoscope channel. (wet gauze must be placed on the plate)
- 6- Insert the surgical instrument into the endoscope channel.
- 7- To activate ENDO-CUT modes, press the yellow footswitch. When ENDO-CUT is activated, the yellow LED on generator turns on and continuous sound is heard. Keep the device activated till the end of desired cutting.

Using Argon Plasma Coagulation

Capability of using argon gas during surgery has been provided in MEG1-E (optionally). For this purpose, APS1 argon gas supplier has been designed as a supplementary device for MEG1-E. APS1 is responsible for controlling and directing argon gas to the surgical probe. By creating high voltage between the electrode tip and tissue surface, argon gas is ionized and a low impedance path is provided for electric current to pass through gas plasma. The ionized gas flow has a bright special blue light. Generally argon system is used for both coagulation and cutting. However cutting with argon is very limited and its main application is surface coagulation. Argon Plasma Coagulation has many advantages, including:

- Ability to control argon beam direction and therefore precise control over surgical site reduces adjacent tissue damage.
- Reducing electrode adhesion to the tissue due to probe distance from tissue surface
- Reducing odor and surgical smoke due to removing oxygen from tissue
- Abroad uniform tissue surface coagulation with high speed
- low coagulation depth

Warning

To use APC, provide APS1 argon gas supplier with MEG1-E. For information on principles of APC, advantages, applications, APS1 installation and interconnection to MEG1-E refer to the User Manual of APS1 device.

In order to observe safety issues and avoid unwanted side effects, always use the lowest power which achieves the desired surgical effect. But in APC, if the risk of gas embolism is remarkable, it may be better to use more powers.

NOTICE

APC is possible only through the Monopolar receptacle.

Alarm Logging System in the Memory

The code associated with each alarm is consisted of two characters. The right character is related to alarm condition type and the left character is related to the mode that in which this alarm has occurred. Characters related to alarm condition type and mode types that alarm has

occurred (during their operation) are given in the following tables.

Alarm condition type	Right character of the code
Voltage increase in internal power supply more than the specified value	1
Decrease in output power of HF generator less than the permitted value	2
Problem in patient plate condition due to Circuit failure of patient plate monitoring	4
Increase in output power of generator more than the permitted value, during activation	5
Disconnection between system internal boards	7
System memory failure	1

Technique	Mode	Left character of the code
Not active	---	0
Monopolar	Pure	1
	Blend	3
	Soft	6
	Spray	7
	Argon	A
Bipolar Coag.	Manual	D

Technical Specifications of Meg1-E

Dimensions and Weight

Width	37 cm
Depth	46 cm
Height	16 cm
Weight	7 kg

Input Power

Mains voltage	200V to 240V, 50HZ
Maximum power consumption	600 VA
Fuse	Standard-5*20mm 3 A - 250 V AC

Internal Memory

Storage capacity	1024 B
------------------	--------

Displays

LCD	LCD display has 4 lines of 20 characters for setting modes and memories and displaying alarms and messages
7-Segment	5, 7-Segments for displaying output powers



LED	4 LED for displaying generator activation in different techniques 2 for displaying connected plate type 1 for displaying plate alarms 1 for displaying alarm existence
-----	---

Current Consumption

Without R.F. power	120 mA
With maximum R.F. Power	2.7 A(rms)

High Frequency Leakage Current

Monopolar	Less than 150 mA
Bipolar	Less than 20 mA
ENDO-CUT	Less than 20 mA

Low Frequency Leakage Current

Normal condition*	Less than 10 μ A
Single fault condition*	Less than 50 μ A

* If all patient terminals are tied together

Output Characteristics*

Monopolar Cut

Mode	Maximum output voltage (V _{P-P})	Maximum output current (A)	Heating Factor (A ² s)	Crest Factor**	Maximum output power (Watts)	Rated load (Ohms)
Pure	920	1.2	39.7	1.6	250	200
Blend	2000	1.1	32.5	2.5	200	350
PapillotomY	1100	0.6	9.8	1.6	360	200
Polypectomy	1100	0.6	10.4	1.6	360	200

Monopolar Coag.

Mode	Maximum output voltage (V _{P-P})	Maximum output current (A)	Heating Factor (A ² s)	Crest Factor**	Maximum output power (Watts)	Rated load (Ohms)
Soft	600	1.0	27.8	1.5	80	150
Spray	5000	0.9	25.9	6 to 9***	80	300
Pulsed Argon	5000	0.9	26.1	6 to 24***	80	300

Bipolar

Mode	Maximum output voltage (V _{P-P})	Maximum output current (A)	Crest Factor**	Maximum output power (Watts)	Rated load (Ohms)
Bipolar Coag.	450	2.2	1.6	80	100

*Nominal Frequency is 410kHz \pm 1kHz.

**Crest Factor is a measurement of waveform which increases by increasing waveform coagulation capabilities and is calculated from the following equation:

$$C.F = V_{peak} / V_{rms}$$

***According to power adjustment

Standards

Meg1-E device meets all relevant clauses of IEC 60601-1, IEC 60601-1-2 and IEC 60601-2-2 standards.

Drip Proof (IEC 60601-2-2)

Meg1-E device is constructed so that in case of liquid spillage in normal use, the safety and performance does not adversely affect.

IEC Classification

Protection class	I
Type of output	CF (Cardiac Floating)
Type of patient circuit	Floating Output

Maximum Output Power Graphs versus Load Resistance in Meg1-E

In these graphs, power level is constant and load value varies. The graphs have been drawn for the two cases of maximum power and half of maximum power in each mode.

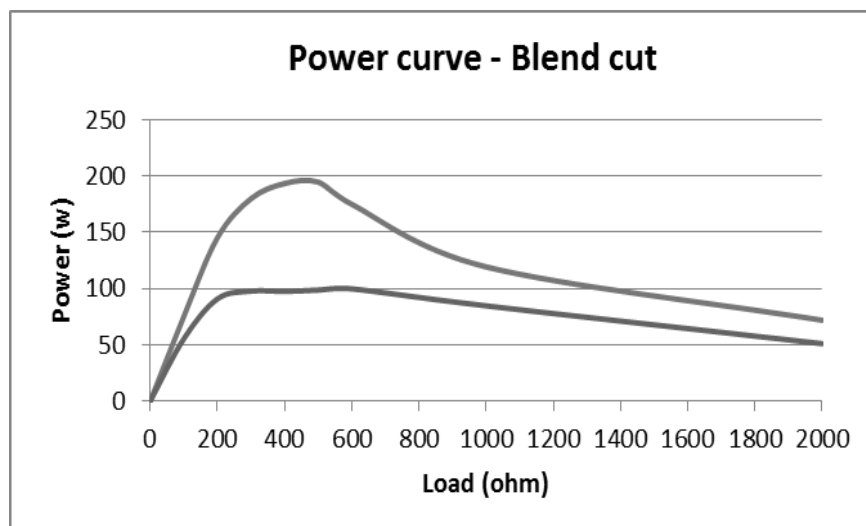
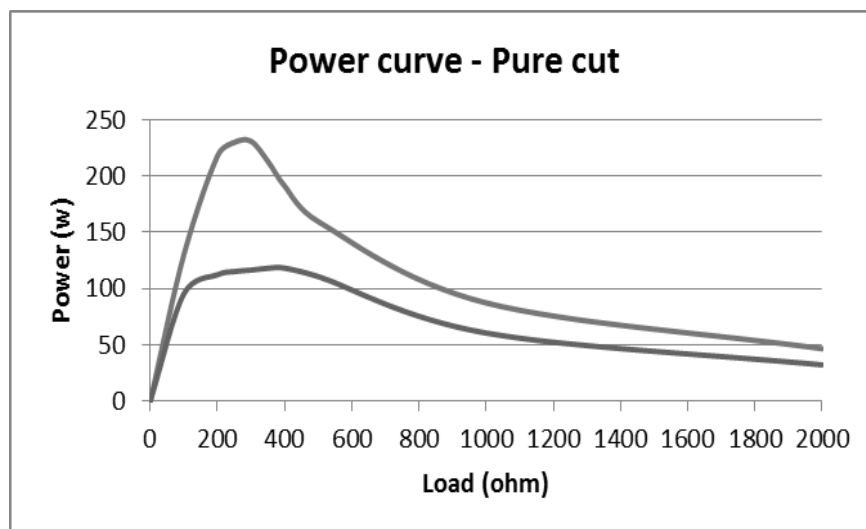

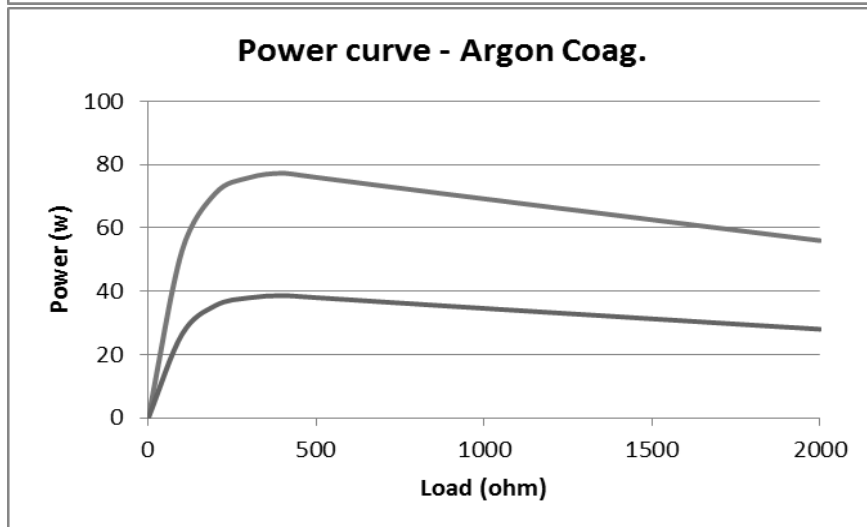
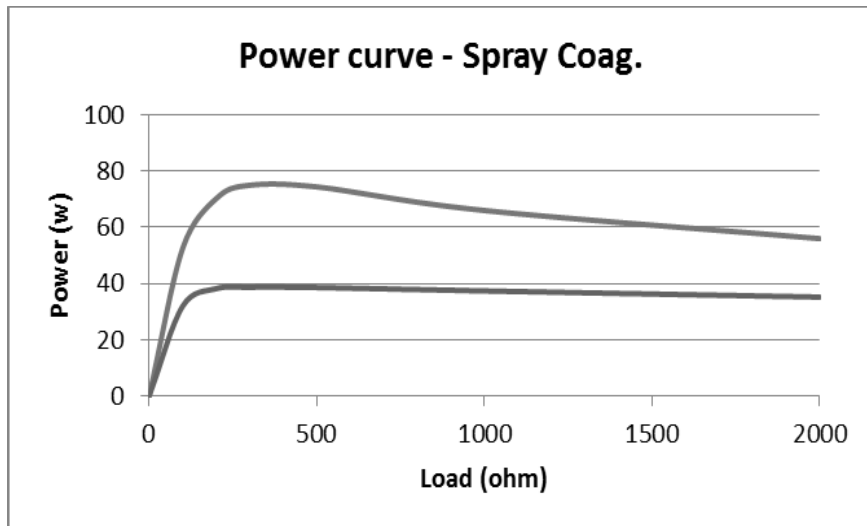
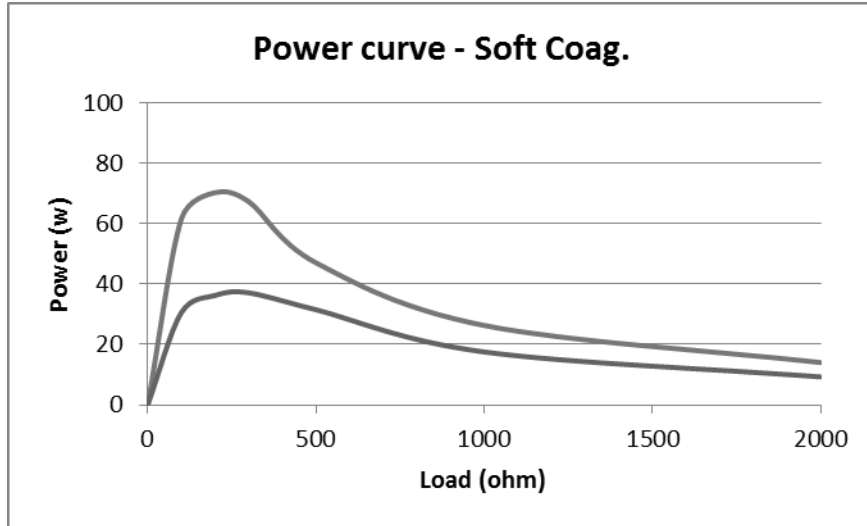

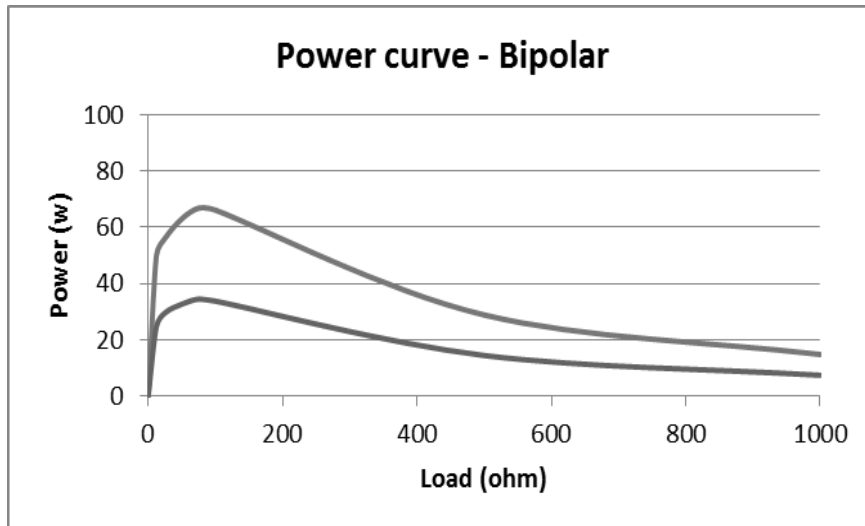

Maximum output power vs load in Endo-cut modes are as follows:

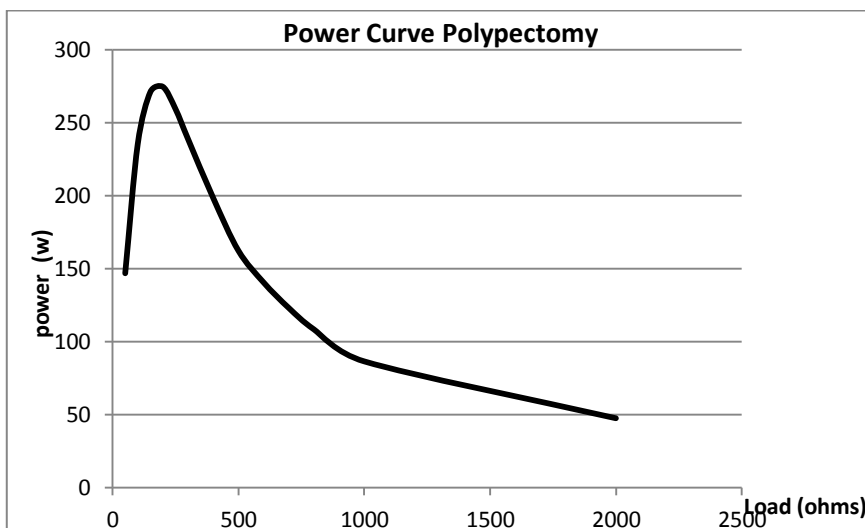
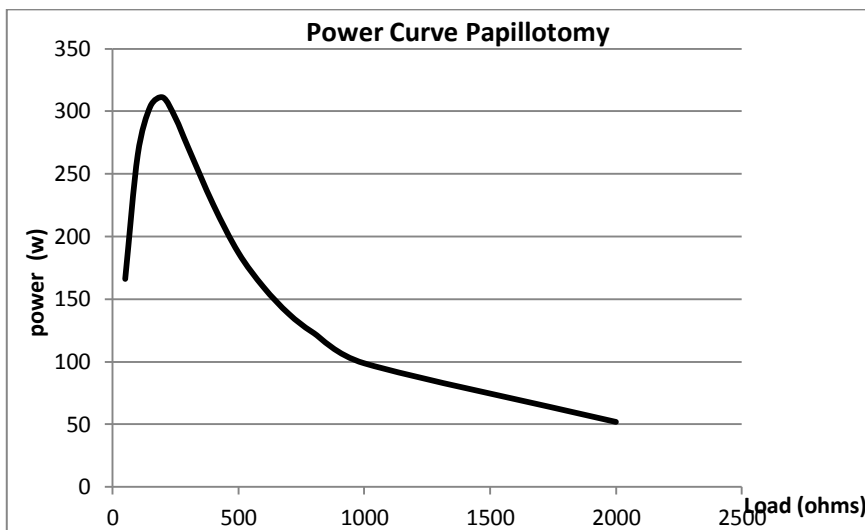



Output Power Graphs versus Adjusted Power Level

In these graphs, load is constant and power level varies from minimum to maximum.

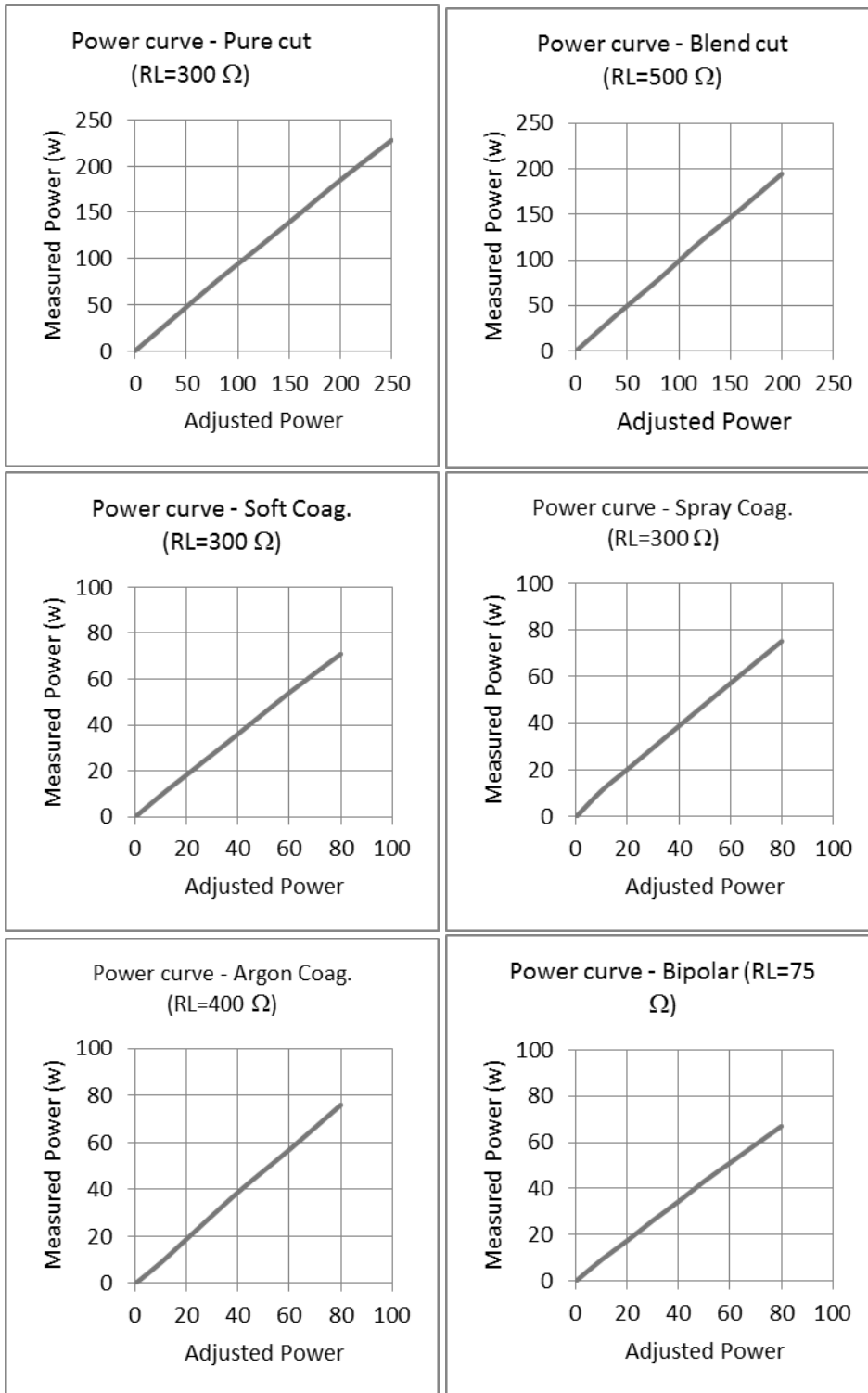

In ENDO-CUT modes, the nominal load is 200 Ω at cutting phase and the maximum output power is 360 watts at all levels.

Annex 2:

Special Features of

MEG1-R

For Radiofrequency Surgery

Electrosurgical Generators

- Introduction
 - Front panel of Meg1-R
 - Back panel of Meg1-R
 - Accessories of Meg1-R
 - Signs Used on Meg1-R
 - Cutting Modes and Power Selection
 - Coagulation Modes and Power Selection
 - Power Level Changes in Monopolar
 - Power Level Changes in Bipolar
 - Alarm Logging System in the Memory
 - Technical Specifications of Meg1-R
-

Introduction

Meg1-R is the state-of –the-art, complete MHZ electrosurgical unit that can be used in specialized plastic and Aesthetic surgeries, Dermatology, ENT, GNY, Ophthalmology and Dentistry. - This device complies with the latest international safety standards, and provides diverse and extensive capabilities in electrical surgery.

Some advantages of RF MHZ technology compared to conventional electrosurgery and laser:

- Due to the higher frequency compared to conventional electrosurgery, cutting is done with less burning or charring of tissue, and minimal damage to the adjacent tissues.
- Enhanced healing, decreased post-surgical edema, less destruction and tissue damage, finer and precise incision and minimal scars.

Front panel of Meg1-R

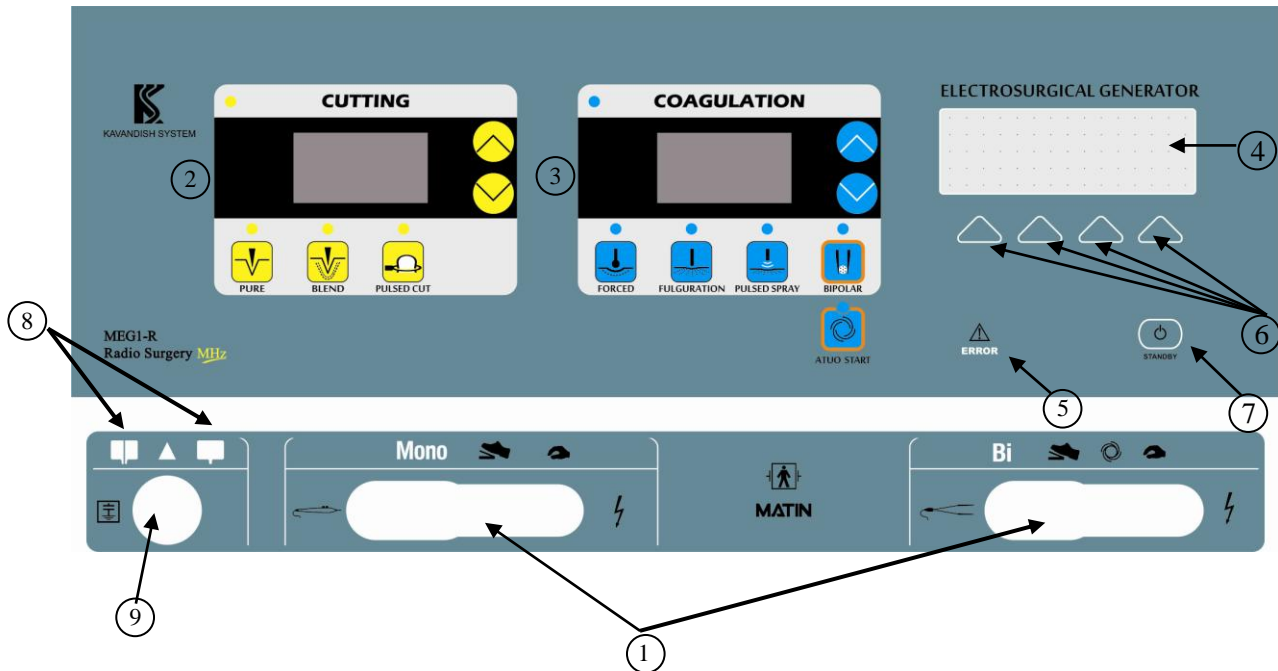

7. Device receptacles for connecting instruments
8. Display and power and mode settings of Cutting technique
9. Display and power and mode settings of Coagulation technique
10. LCD
11. Alarm indicator LED (except plate alarms)
12. Four-key keypad
13. Standby button
14. Plate connection indicator LED and related alarm
15. Dual and single pad plate receptacle

Back panel of Meg1-R

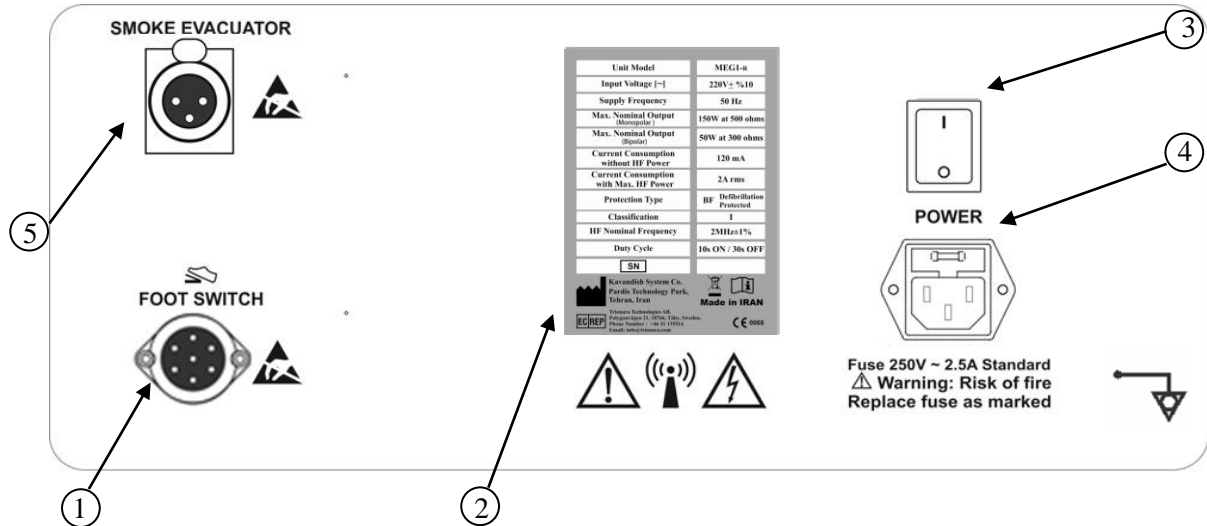

1. Double pedal footswitch receptacle
2. Device identification label
3. Main power switch
4. Line cord receptacle and Input Fuse place.
5. IVAC device receptacle

Accessories of Meg1-R

The following accessories are included in the Meg1-R packaging according to the customer's order:

1. Single-use Monopolar pen
2. Monopolar tips
3. Single-use Dual Plate
4. Plate cable
5. Bipolar forceps
6. Bipolar cable
7. Mains power cable
8. Double pedal footswitch

Signs Used on Meg1-R



The degree of protection against electric shock is of BF type and low frequency leakage currents are negligible. Also the device is protected against high voltage due to defibrillator use for patient.



The plate is Earth Referenced, which means that the plate is not isolated from the earth at high frequencies and it is connected to the earth with a low impedance capacitor inside the device.



Equipotential terminal

This terminal is Equipotential with metal enclosure of device (protective earth).

WARNING

Advantages of RF generators in tissue cutting are attainable when using fine electrodes with a small diameter. There is more damage to the adjacent tissues if a thick electrode with a large diameter is used

This device is not suitable for operations in which the surgical instrument comes into direct contact with the heart.

Be sure to connect the plate to the patient to prevent leakage currents from unwanted paths. unwanted paths may be any points of the patient's body that are in contact with metal objects (such as laparoscopic equipment, other devices such as monitoring equipment, etc.) or any other path from the patient's body to the ground such as the operator's body

In dual plates, perfect contact with the patient's body is very important, and if there is a problem in plate's contact, the device detects it and generates an alarm. The use of dual plates considerably reduces the risk of unwanted burns.

Kavandish System suggests using dual plates as far as possible to improve patient safety. In case of single plate use, contact quality of plate will not be monitored by the device and patient plate loosening may create hazardous situations or HF burns

Volume Adjustment

To adjust the volume, use up and down buttons under the LCD while the generator is activated.

Cutting Mode and Power selection

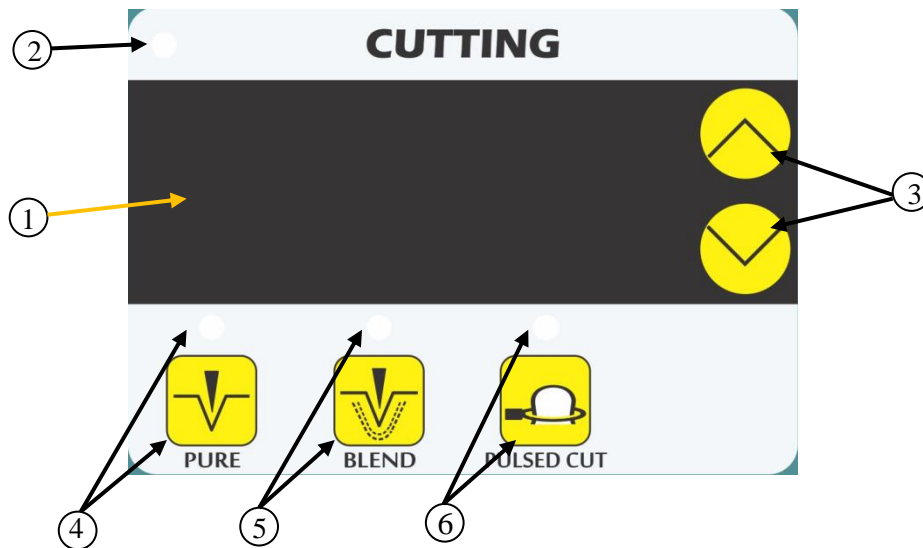

1. Display of Monopolar Cutting output power
2. Indicator of Monopolar Cutting activation
3. Cutting output power settings buttons
4. Button and indicator of Pure mode selection
5. Button and indicator of Blend mode selection
6. Button and indicator of Pulsed Cut mode selection

Output power will change in certain step by each press on output power setting buttons or keeping a finger on them.

Cut modes

Pure (pure cut): This mode provides pure and smooth cut with minimum coagulation in surrounding tissues and is appropriate for cutting skin and aesthetic surgeries. It can also be used for tissue sampling since minimum alteration to tissue is caused.

Blend: In this mode in addition to cutting, the tissues adjacent to electrode will be coagulated. This mode is suitable for removing moles, warts and skin lesions.

Pulsed Cut: Electric current applies according to tissue impedance in form of intermittent pulses. Having separate cut phase and coagulation phase, prevents sudden and deep cuts and provides more control over cutting.

This mode is applicable when a loop electrode is used to remove polyp or a large mole, and the contact surface of the electrode to tissue is large. Due to its significant power, this mode is not suitable for surgical treatment of small diameter polyps.

Coagulation Mode and Power Selection

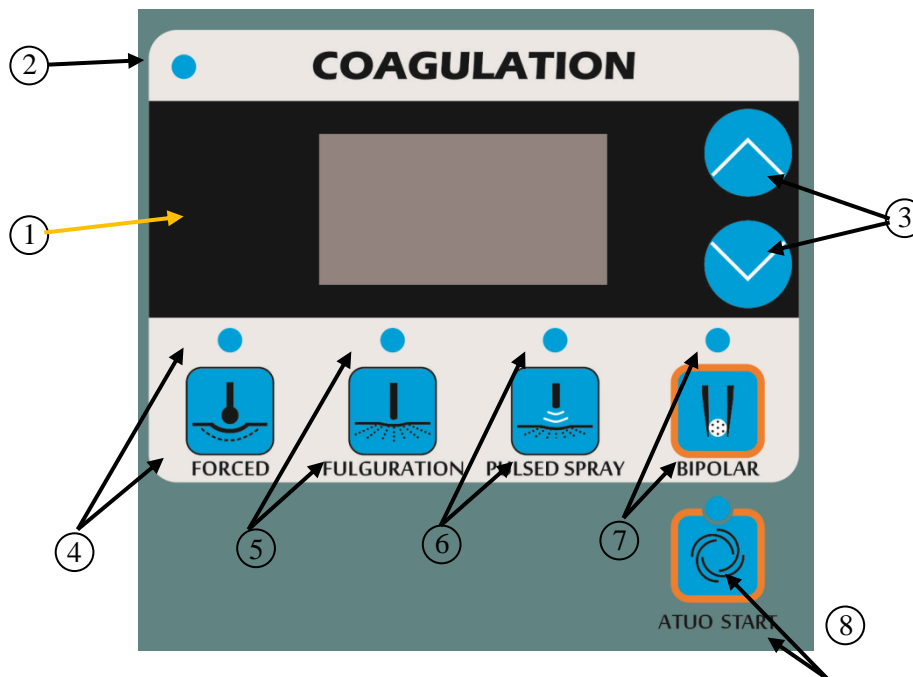

1. Display of Monopolar Coag. output power
2. Indicator of Monopolar Coag. activation
3. Monopolar Coag. output power setting buttons
4. Button and indicator of Forced mode selection
5. Button and indicator of Fulguration mode selection
6. Button and indicator of Pulsed Spray mode selection
7. Button and indicator of Bipolar Coag. mode selection
8. Button and indicator of Auto-start Bipolar Coag. mode selection

Coagulation modes

Forced: This mode is used for coagulation of tissues and small vessels. Ball electrodes or thick electrodes with large surface are used in this mode.

If finer electrodes are applied, this mode can also be used for cutting or to stop bleeding and compared to blend mode, more coagulation is achieved but surrounding tissues are affected more.

Fulguration: maximum bleeding halt is achieved compared with other modes and suitable for tissue desiccation. Arcs and sparks can be achieved and appropriate for tissue destruction (for example tumor ablation)

Pulsed Spray: suitable for surface coagulation and used where electrode is not intended to stick to tissue and distance of 1mm be kept from tissue.

Bipolar Coagulation: fine coagulation with minimum carbonization and tissue injury. This mode is suitable for patients with pacemakers.

Auto Start: In this case, the Bipolar output is automatically activated as soon as the two tips of the forceps touch the tissue (with a delay of 0.5 seconds for safety). If the footswitch button is assigned for Bipolar and footswitch pressed, the Auto Start mode will immediately change to Manual mode.

Power Level Changes in Monopolar

In Meg1-R, Monopolar adjustable power level is divided into different ranges. For monopolar modes except Pulsed cut, step of power level changes in various ranges is different:

- Range 1: from 0 to 50 with step 1
- Range 2: from 50 to 100 with step 2
- Range 3: from 105 to 120 with step 5

Pulsed cut technique has 4 steps of power as following. The greater the power, the greater the intensity of cut and coagulation.

- Step 1: 50
- Step 2: 80
- Step 3: 110
- Step 4: 150

Power Level Changes in Bipolar

Given that the Bipolar is usually used for Coagulation, the power indicator and power adjustment buttons for this mode are common with other Coagulation modes. But due to the usual limited power in bipolar, the steps of power are divided into smaller ranges. The steps of power level are different in various ranges.

- Range 1: from 0 to 1 with step 0.1
- Range 2: from 1 to 5 with step 0.2
- Range 3: from 5 to 10 with step 0.5
- Range 4: from 10 to 20 with step 1
- Range 5: from 20 to 50 with step 2

Saving alarms in the Memory

The code associated with each alarm is consisted of two characters. The right character is related to alarm condition type and the left character is related to the mode that in which this alarm has occurred. Characters related to alarm condition type and mode types that alarm has occurred (during their operation) are given in the following tables.

Alarm condition type	Right character of the code
Voltage increase in internal power supply more than the specified value	1
Decrease in output power of HF generator less than the permitted value	2
Problem in patient plate condition due to Circuit failure of patient plate monitoring	4
Increase in output power of generator more than the permitted value, during activation	5
Disconnection between system internal boards	7
System memory failure	1

Technique	Mode	Left character of the code
Not active	---	0
Monopolar	Pure	1
	Blend	3
	Forced	6
	Fulguration	7
	Pulsed Cut	A
Bipolar Coag.	Manual	D

Technical Specifications of Meg1-R

Dimensions and Weight

Width	37 cm
Depth	46 cm
Height	16 cm
Weight	7 kg

Input Power

Mains voltage	200V to 240V, 50HZ
Maximum power consumption	600 VA
Fuse	Standard-5*20mm 2.5 A - 250 V AC

Internal Memory

Storage capacity	1024 B
------------------	--------

Displays

LCD	LCD display has 4 lines of 20 characters for setting modes and memories and displaying alarms and messages
7-Segment	5, 7-Segments for displaying output powers
LED	4 LED for displaying generator activation in different techniques 2 for displaying connected plate type 1 for displaying plate alarms 1 for displaying alarm existence (except plate alarms)

Current Consumption

Without R.F. power	120 mA
With maximum R.F. Power	2 A(rms)

High Frequency Leakage Current

Monopolar	Less than 150 mA
Bipolar	Less than 50 mA

Low Frequency Leakage Current

Normal condition	Less than 10 μ A
Single fault condition	Less than 500 μ A

Output Characteristics*

Monopolar Cut

Mode	Maximum output voltage (V _{P-P})	Maximum output current (A)	Heating Factor (A ² s)	Crest Factor**	Maximum output power (Watts)	Rated load (Ohms)
Pure	1600	0.8	17.9	1.7	120	600
Blend	1600	0.8	17.7	1.7	100	600
Pulsed Cut	1700	0.4	4.5	1.7	150	600

Monopolar Coag.

Mode	Maximum output voltage (V _{P-P})	Maximum output current (A)	Heating Factor (A ² s)	Crest Factor**	Maximum output power (Watts)	Rated load (Ohms)
Forced	2050	1.1	35	2.1	100	500
Fulguration	3000	0.5	6.2	5.5	25	600
Pulsed Spray	3000	0.5	6.2	5.5	25	600

Bipolar

Mode	Maximum output voltage (V _{P-P})	Maximum output current (A)	Crest Factor**	Maximum output power (Watts)	Rated load (Ohms)
Bipolar Coag. Auto Start Bipolar Coag.	700	1.0	1.75	50	250

*Nominal Frequency is 2MHz±20kHz.

**Crest Factor is a measurement of waveform which increases by increasing waveform coagulation capabilities and is calculated from the following equation:

$$C.F = V_{peak} / V_{rms}$$

Standards

Meg1-R device meets all relevant clauses of IEC 60601-1, IEC 60601-1-2 and IEC 60601-2-2 standards.

Drip Proof (IEC 60601-2-2)

Meg1-R device is constructed so that in case of liquid spillage in normal use, the safety and performance does not adversely affect.

IEC Classification

Protection class	I
Type of output	BF (Body Floating) defibrillation proof
Type of patient circuit	Earth referenced



Maximum Output Power Graphs versus Load Resistance in Meg1-R

In these graphs, power level is constant and load value varies. The graphs have been drawn for the two cases of maximum power and half of maximum power in each mode.

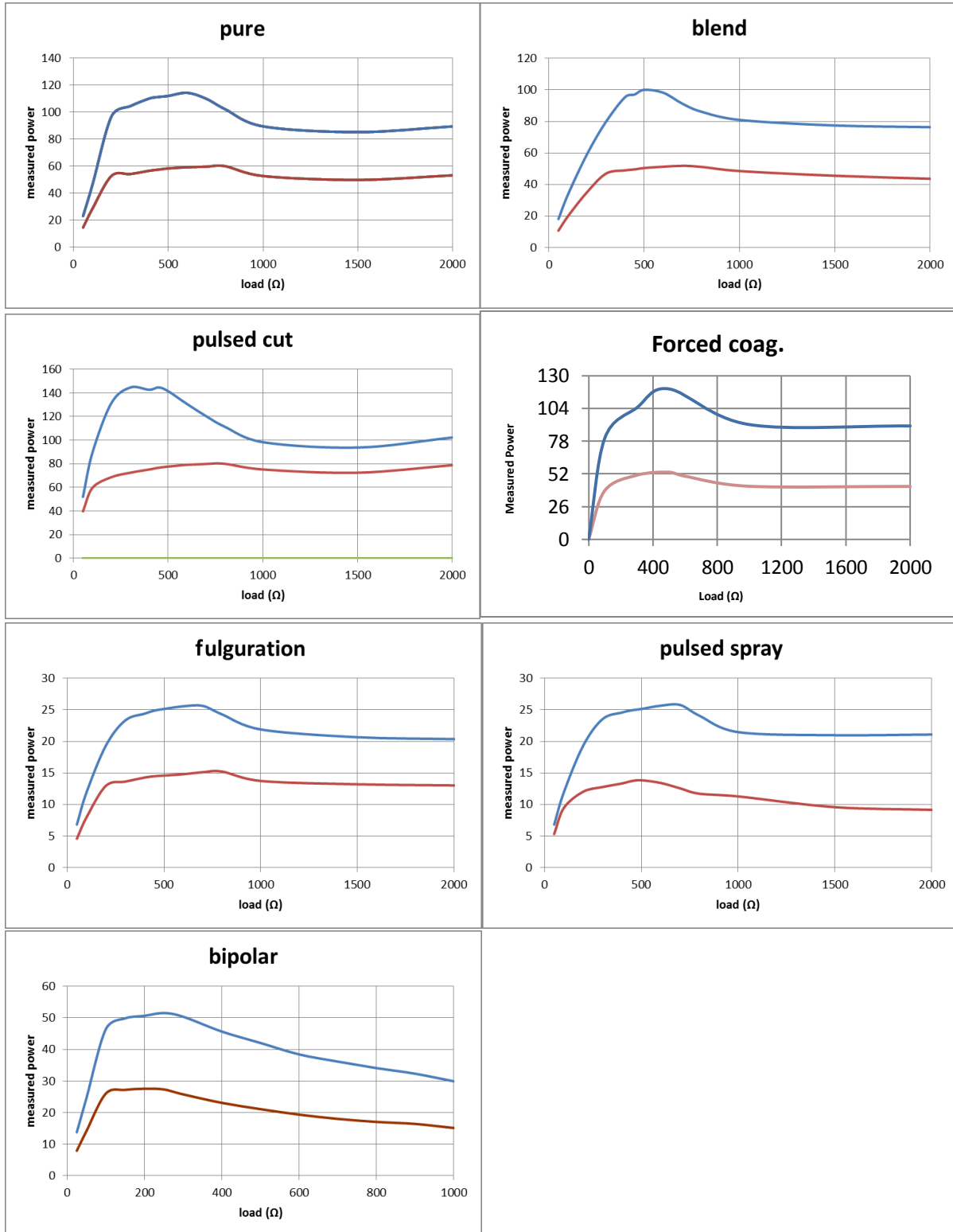

Output Power Graphs versus Adjusted Power Level in Meg1-R

In these graphs, load is constant and power level varies from minimum to maximum.

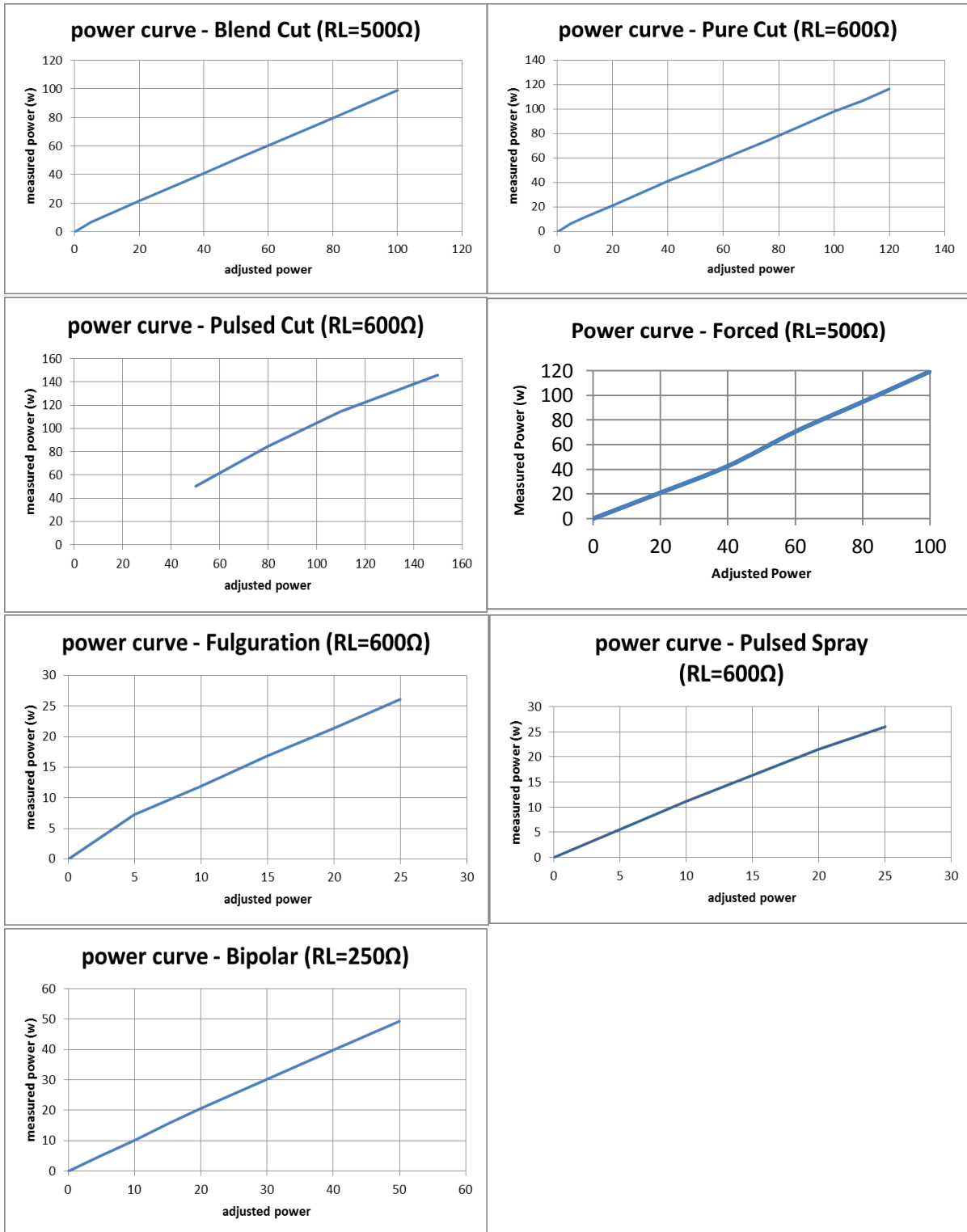

Annex 3:

Special Features of **MEG1 with Bipolar TUR** Electrosurgical Generators

- Introduction
 - Front panel of Meg1 with Bipolar TUR
 - Monopolar Cutting Modes and Power Selection
 - Monopolar Coagulation Modes and Power Selection
 - Bipolar Modes and Power Selection
 - Alarm Conditions
 - Technical Specifications of Meg1 with Bipolar TUR
-

Introduction

The MEG1 electrosurgical unit with BIPOLAR TUR is optimized for use in urology surgeries. In Bipolar TUR mode, the output power can be increased up to 250 Watts. This significant power makes cutting easy in normal saline. Also, in this device, Monopolar TUR modes including Pure TUR and Blend TUR are available. MEG1 with BIPOLAR TUR covers all common electrosurgical applications with a wide range of output power from less than 0.1 Watt to close to 300 Watts and facilitate all the need in general and specialized surgeries. These techniques are:

- a. Monopolar Cutting
- b. Monopolar Coagulation
- c. Bipolar Coagulation
- d. Bipolar Cutting
- e. Bipolar & Monopolar TUR

Front panel of Meg1 with Bipolar TUR

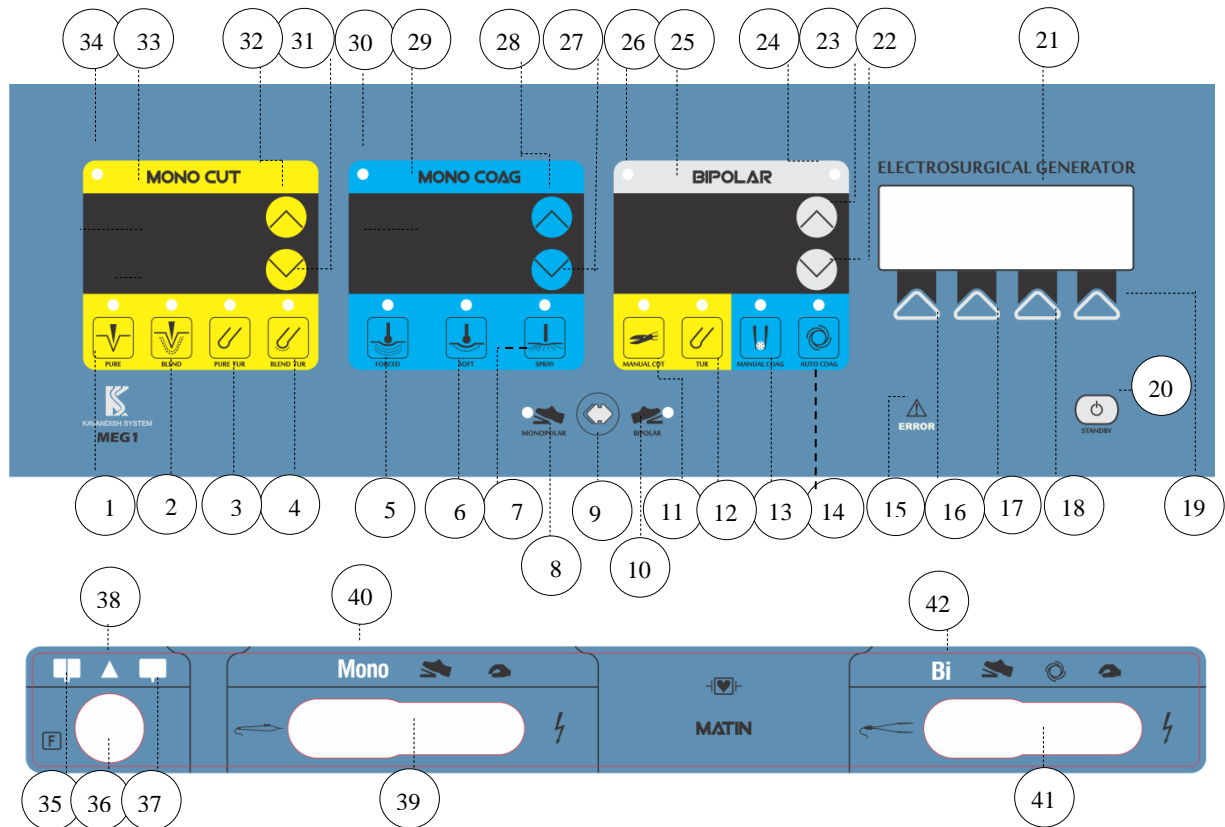

1. This pushbutton and indicator light selects pure cutting mode.
2. This pushbutton and indicator light selects Blend.
3. This pushbutton and indicator light selects Pure TUR.
4. This pushbutton and indicator light selects Blend TUR.
5. This pushbutton and indicator light selects forced coagulation.
6. This pushbutton and indicator light selects Soft coagulation.
7. This pushbutton and indicator light selects spray coagulation or fulguration.
8. This indicator light switches pedal footswitch to monopolar mode.
9. This pushbutton switches footswitch to bipolar or monopolar generator.

10. This indicator light selects bipolar mode for pedal footswitch.
11. This indicator light selects manual Bipolar Cutting.
Bipolar output is activated only by pressing footswitch.
12. This pushbutton and indicator light selects Bipolar TUR.
13. This indicator light selects manual Bipolar Coagulation.
Bipolar output is activated only by pressing footswitch.
14. This pushbutton and indicator light selects auto-start mode.
15. This indicator light informs you that an error has been occurred because of an internal damage, or operator mistake.
16. This pushbutton selects a mode in order to return to the previous page in LCD display (LCD adjustment).
17. This pushbutton selects the mode to move LCD display downwards to select desired options.
18. This pushbutton selects the mode to move LCD display upwards to select desired options.
19. This pushbutton selects and confirms the continuation of the operation or operation path; in the LCD display (complete explanation about various menus of LCD will be notified in Chapter 6, under the title of “Introduction of LCD display pages”).
20. This pushbutton sets the equipment in the standby mode. In order to activate standby mode, you should press this button and hold your finger on it 1 to 2 seconds. In this case the equipment will not run any command. Notice that whenever you exit from this mode, the unit will turn on and operate commands. In order to exit from the standby mode, press the button again and hold it 1 to 2 seconds (when the equipment is in the standby mode, all of previous saved data will be reserved in the unit memory and as soon as the unit exits from this mode, all of saved data will be displayed. However, electric current interruption will disappear all of the saved data).
21. LCD display which is used to display and adjust modes, memories, and messages.
22. This pushbutton decreases Bipolar output power.
23. This pushbutton increases the Bipolar output power.
24. This indicator light indicates the activation of Bipolar coagulation generator.
25. This digital display indicates the Bipolar output power.
26. This indicator light indicates the activation of Bipolar cutting.
27. This pushbutton decreases the monopolar output power in coagulation mode.
28. This pushbutton increases the monopolar output power in coagulation mode.
If you press buttons 27 and 28 or hold your finger on them, you will observe changes of the level on



digital display 29. These changes are achieved in the form of separate steps in order that selecting the levels can be fulfilled more accurately.

29. This digital display indicates monopolar output power in coagulation mode.

30. These indicator lights indicate the activation of monopolar coagulation generator.

31. This pushbutton decreases the monopolar power output in cut mode.

32. This pushbutton increases the monopolar power output in cut mode.

If you press buttons 31 and 32 one time or hold your finger on them, you will observe changes of the level on digital display 33.

These changes are applied in the form of separate steps in order that selecting the levels can be fulfilled more accurately.

33. This digital display indicates the monopolar power output in cut mode.

34. These indicator lights indicate the activation of monopolar cut generator.

35. This indicator light indicates the connection of Dual Pad plate to the unit and indicates that the contact quality of plate with patient is acceptable.

36. Connection place of single and dual pad patient plate to the unit.

37. This indicator light indicates the connection of Single Pad plate to the unit.

38. This warning indicator light is related to patient plate.

Whenever the patient plate disconnects from the unit or a problem occurs along the plate connection path which causes the impedance discrepancy between two tips of connection path increased more than 150 ohms, this warning light will turn on.

39. Connection place of monopolar pen to the unit. (For more explanation about monopolar connection, refer to

Chapter 4).

40. This indicator light indicates the activation of monopolar output.

41. Connection place of Bipolar pen. (For more explanation about bipolar connection, refer to

Chapter 5).

42. This indicator light indicates the activation of bipolar generator.

Monopolar Cutting Modes and Power selection

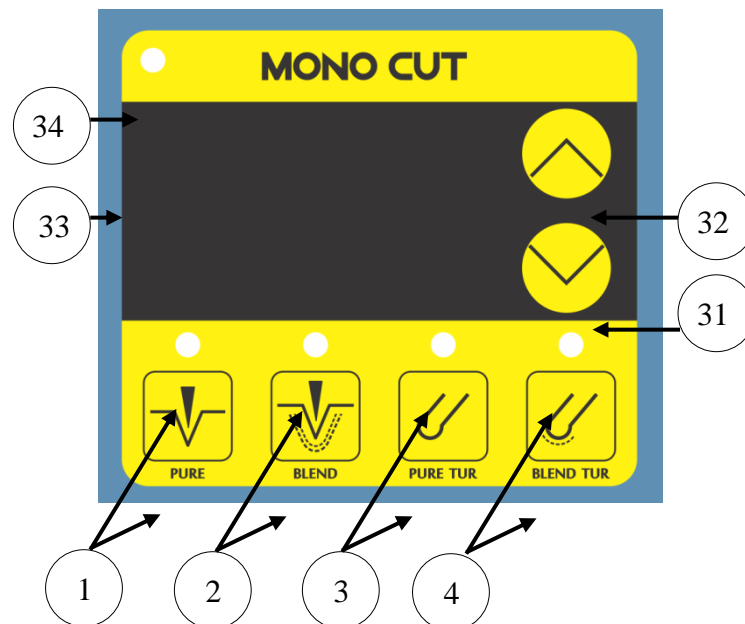

- 1) Button and indicator of Pure mode selection
- 2) Button and indicator of Blend mode selection
- 3) Button and indicator of Pure TUR mode selection
- 4) Button and indicator of Blend TUR mode selection
- 31, 32) Cutting output power settings buttons
- 33) Display of Monopolar Cutting output power
- 34) Indicator of Monopolar Cutting activation

Output power will change in certain step by each press on output power setting buttons or keeping a finger on them.

Cut modes

Pure: This mode provides pure and smooth cut with minimum coagulation in surrounding tissues and is appropriate for cutting skin and aesthetic surgeries. It can also be used for tissue sampling since minimum alteration to tissue is caused. This mode is used when bleeding is negligible.

Blend: In this mode in addition to cutting, the tissues adjacent to electrode will be coagulated.

Pure TUR: This mode has been prepared for surgery in fluid environments such as bladder and prostate and cause pure cut.

Blend TUR: This mode has been prepared for surgery in fluid environments such as bladder and prostate. In addition to cutting, this mode creates more coagulation.

Monopolar Coagulation Modes and Power selection

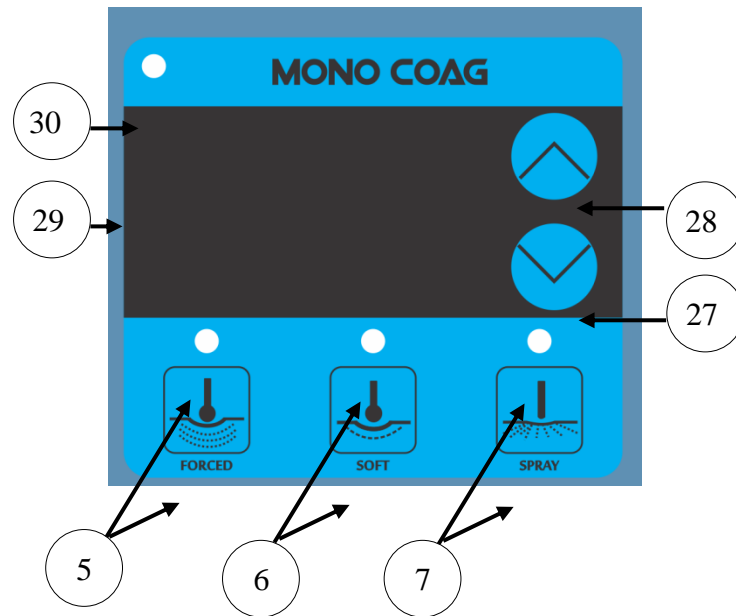

- 5. Button and indicator of Forced mode selection
- 6. Button and indicator of Soft mode selection
- 7. and indicator of Spray mode selection
- 27, 28. Monopolar Coag output power setting buttons
- 29. Display of Monopolar Coag output power
- 30. Indicator of Monopolar Coag activation

Output power will change in certain step by each press on output power setting buttons or keeping a finger on them.

Coagulation modes

Forced: This mode is used for deep coagulation of tissues using electrodes with small cross section. There is a stronger modulation in this mode. It is better to use this mode when electrode has a smaller surface and relatively deep coagulation is needed.

Soft: This mode is used for soft coagulation of tissues without carbonization and adhesive effects of tissue to electrode. In this mode, the output voltage is lower than the other coagulation modes.

Spray: This mode is used for coagulation of tissues surfaces with low depth without contacting the electrode with tissue. The main feature of this mode compared to others is its more electric arc intensity and the possibility of coagulation by the use of electric arc without direct contact of electrode with tissue. This mode is appropriate for minimizing the effects of cutting and tissue separation.

Bipolar Modes and Power selection

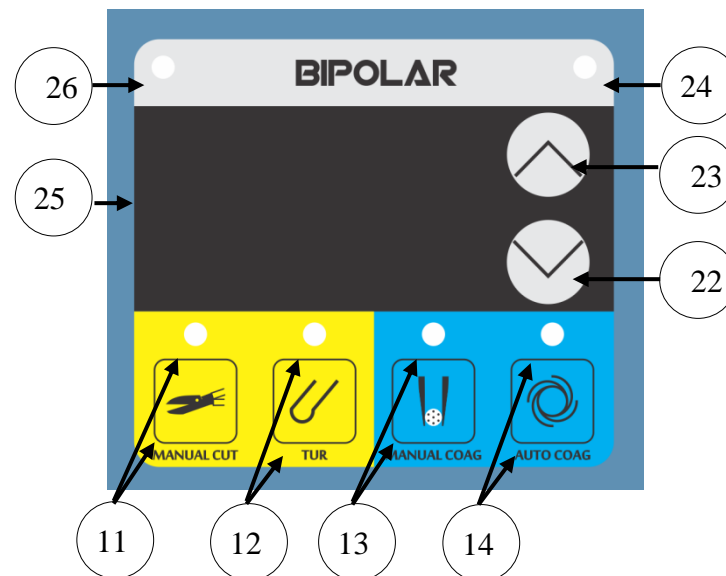

11. This indicator light selects manual Bipolar Cutting. Bipolar output is activated only by pressing footswitch.

12. This pushbutton and indicator light selects Bipolar TUR.

13. This indicator light selects manual Bipolar Coagulation. Bipolar output is activated only by pressing footswitch.

14. This pushbutton and indicator light selects auto-start Bipolar Coagulation mode (tissue sense). Bipolar output is automatically activated as soon as the two tips of the forceps touch the tissue (with a delay of 0.5 seconds for safety). If the footswitch button is assigned for Bipolar and footswitch pressed, the Auto Start mode will immediately change to Manual mode.

22. This pushbutton decreases Bipolar output power.

23. This pushbutton increases the Bipolar output power.

24. This indicator light indicates the activation of Bipolar coagulation generator.

25. This digital display indicates the Bipolar output power.

26. This indicator light indicates the activation of Bipolar cutting.



Power Level Changes in Bipolar

In Meg1 with Bipolar TUR, Bipolar adjustable power level is divided into different ranges. Step of power level changes in various ranges is different:

- Range 1: from 0 to 1 with step 0.1
- Range 2: from 1 to 5 with step 0.2
- Range 3: from 5 to 10 with step 0.5
- Range 4: from 10 to 20 with step 1
- Range 5: from 20 to 100 with step 2
- Range 6: from 100 to the end with step 5

Alarm Conditions

Alarm conditions in MEG1 with Bipolar TUR is the same as MEG1 (see page 55) except “Fail: p>100” alarm. In addition, MEG1 with Bipolar TUR has following alarms:

Event	Message on the LCD	Group	Priority	Impact on the activity	Log (in memory)
Using the device more than 30s continuously in the power greater than 100 Watt. Due to uncommon use, device has stopped. Let the device to cool down for about 1 minute.	Heat Factor 1	Functional	Medium	Deny the permission or stop of Monopolar activity	×
Using the device continuously in monopolar mode with high current. Possibility of temperature increase in plate place. Deactivate the device and let the plate place to cool down.	Heat Factor 2	Functional	Low	--	×
Using the device continuously in monopolar mode with high current. Possibility of temperature increase in plate place. Due to the unusual device use, the device is deactivated. Let the plate place to cool down.	Heat Factor 3	Functional	Medium	Deny the permission or stop of Monopolar activity	×

Technical Specifications of Meg1 with Bipolar TUR

Dimensions and Weight

Width	37 cm
Depth	46 cm
Height	16 cm
Weight	7 kg

Input Power

Mains voltage	200V to 240V, 50HZ
Maximum consumption	power 675 VA
Fuse	Standard-5*20mm 3 A - 250 V AC

Internal Memory

Storage capacity	1024 B (1 KB)
------------------	---------------

Displays

LCD	LCD display has 4 lines of 20 characters for setting modes and memories and displaying alarms and messages
7-Segment	9, 7-Segments for displaying output powers
LED	6 LED for displaying generator activation in different techniques 2 for displaying connected plate type 1 for displaying plate alarms 1 for displaying alarm existence (except plate alarms) 2 for displaying which technique is activated by pressing footswitch

Current Consumption

Without R.F. power	146 mA
With maximum R.F. Power	2.9 A(rms)

High Frequency Leakage Current

Monopolar	Less than 150 mA
Bipolar	Less than 20 mA

Low Frequency Leakage Current

Normal condition*	Less than 10 μ A
Single fault condition*	Less than 50 μ A

* If all patient terminals are tied together



Output Characteristics*

Monopolar Cut

Mode	Maximum output voltage (V _{P-P})	Maximum output current (A)	Heating Factor (A ² s)	Crest Factor**	Maximum output power (Watts)	Rated load (Ohms)
Pure, Pure TUR	900	1.1	33.7	1.4	300	200
Blend, Blend TUR	2000	1.1	31.3	2.3	200	400

Monopolar Coag.

Mode	Maximum output voltage (V _{P-P})	Maximum output current (A)	Heating Factor (A ² s)	Crest Factor**	Maximum output power (Watts)	Rated load (Ohms)
Forced	2400	0.9	19.6	3.4	80	400
Soft	500	0.9	22.1	1.5	80	200
Spray	5000	0.9	22.5	5.5 to 7.5***	80	500

Bipolar

Mode	Maximum output voltage (V _{P-P})	Maximum output current (A)	Crest Factor**	Maximum output power (Watts)	Rated load (Ohms)
Bipolar Cut	820	3.7	1.5 to 2.8***	200	100
Bipolar TUR	920	4.1	1.5 to 2.8***	250	100
Bipolar Coag. Auto Start Bipolar Coag.	460	3.1	1.5	150	100

*Nominal Frequency is 410kHz±1kHz.

**Crest Factor is a measurement of waveform which increases by increasing waveform coagulation capabilities and is calculated from the following equation:

$$C.F = V_{peak} / V_{rms}$$

***According to power adjustment

IEC Classification

Protection class	I
Type of output	CF (Cardiac Floating)
Type of patient circuit	Floating Output

Maximum Output Power Graphs versus Load Resistance in Meg1 with Bipolar TUR

In these graphs, power level is constant and load value varies. The graphs have been drawn for the two cases of maximum power and half of maximum power in each mode.

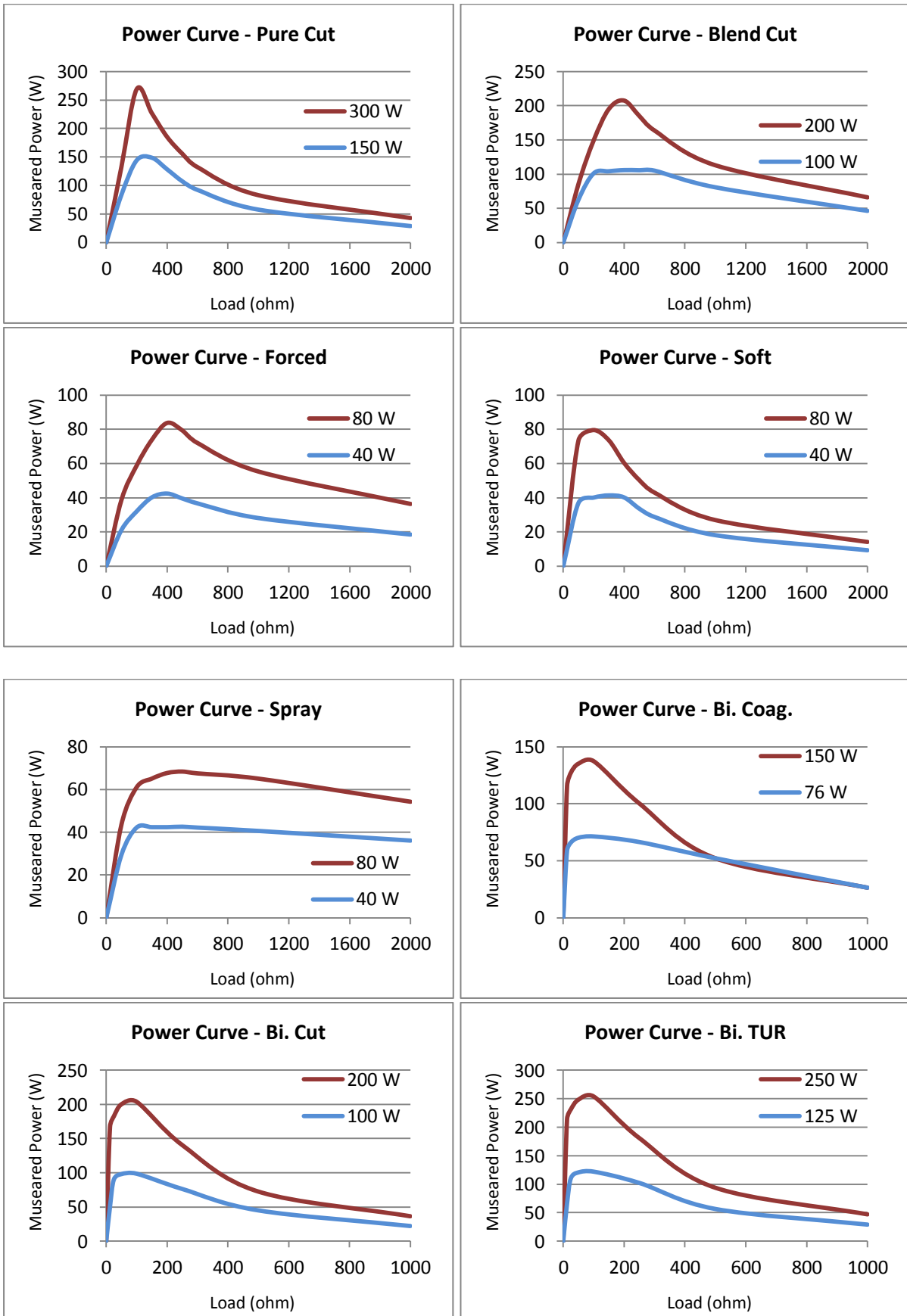



Output Power Graphs versus Adjusted Power Level in Meg1 with Bipolar TUR

In these graphs, load is constant and power level varies from minimum to maximum.

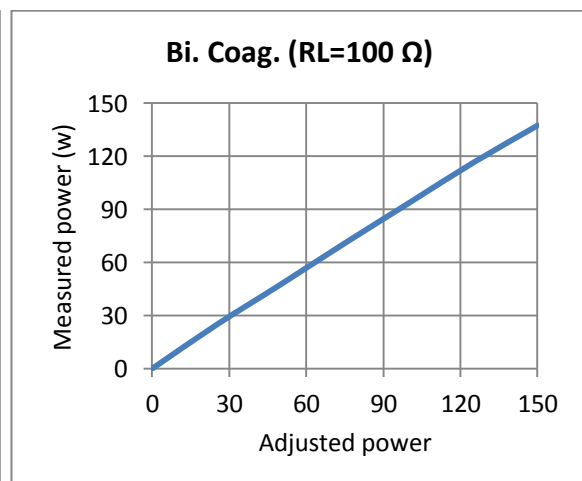
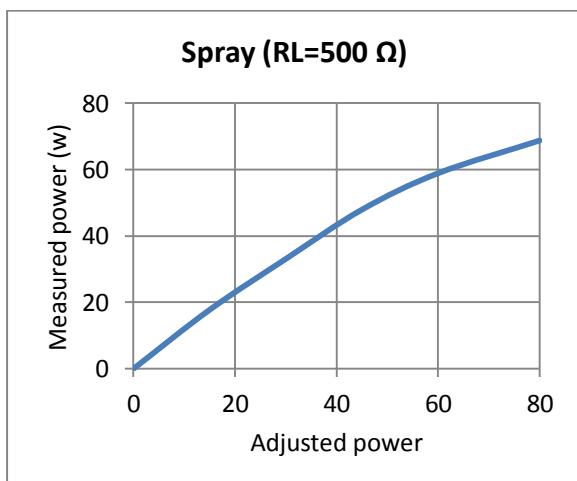
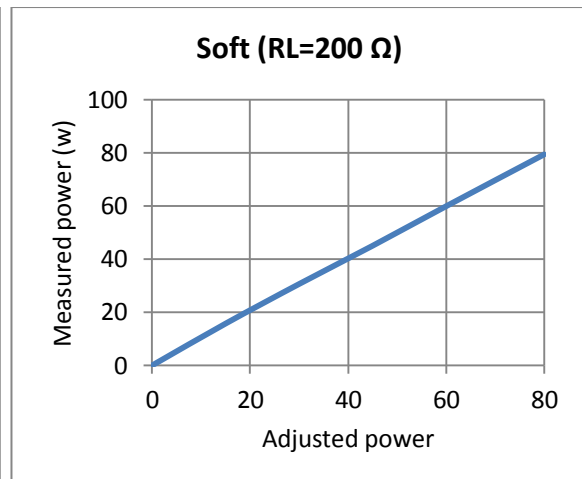
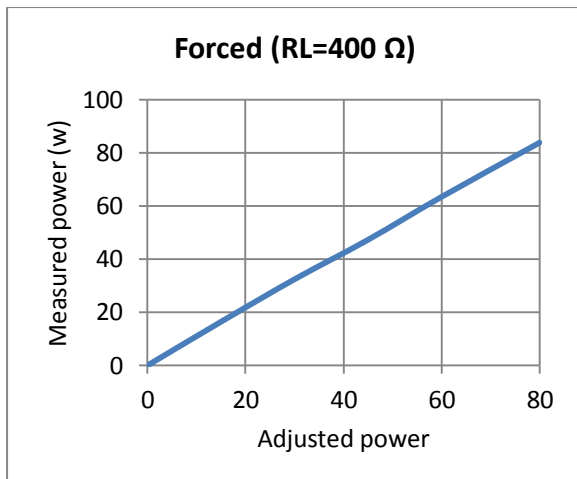
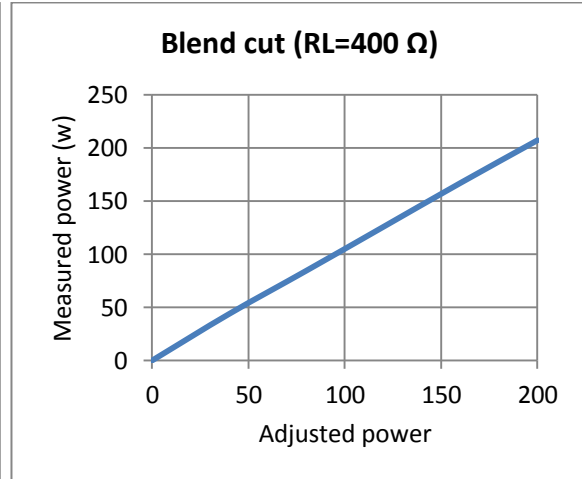
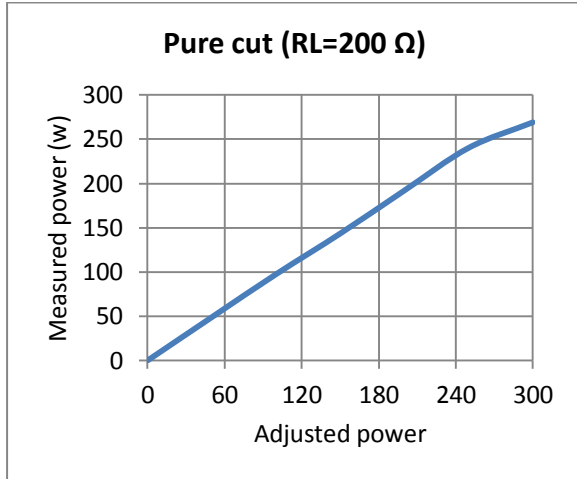

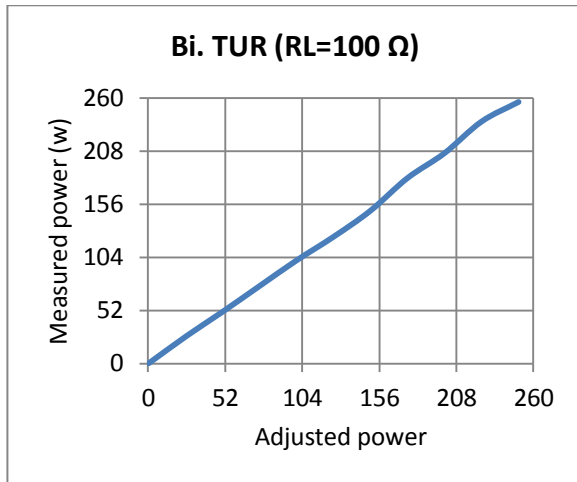
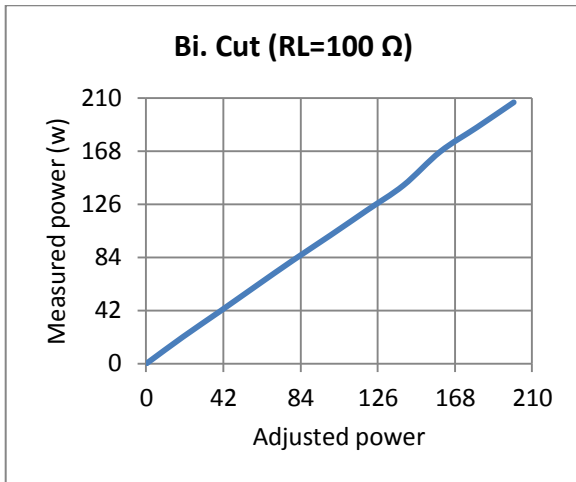

Maximum Output Voltage Graphs versus Adjusted Power Level in Meg1 with Bipolar TUR

In these graphs, output voltages are measured in open circuit condition in different power levels.

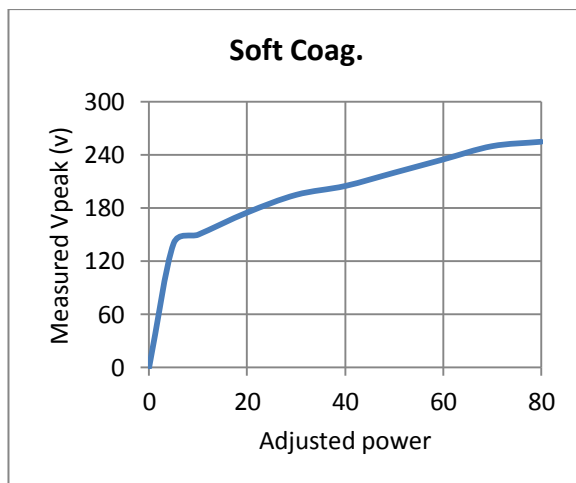
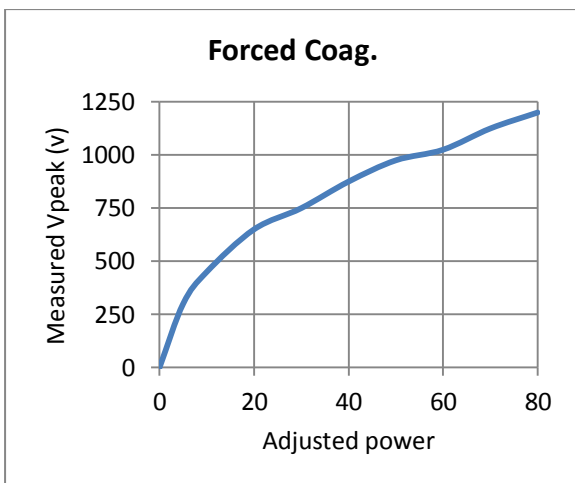
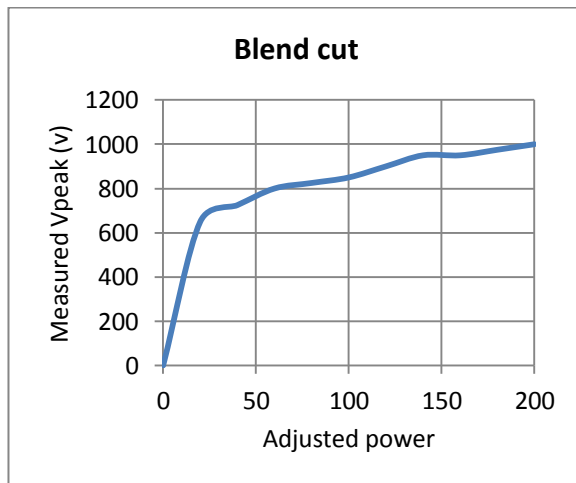
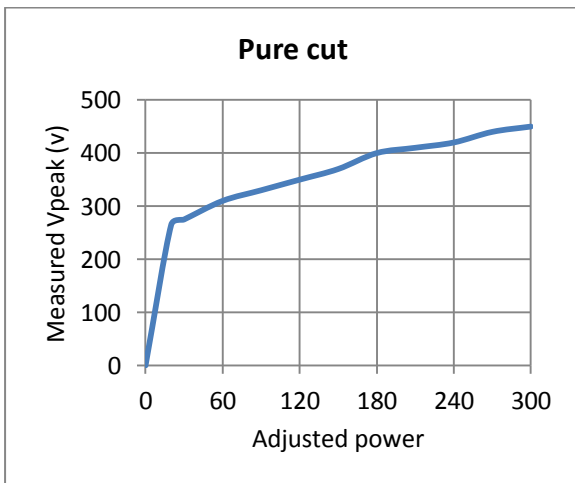

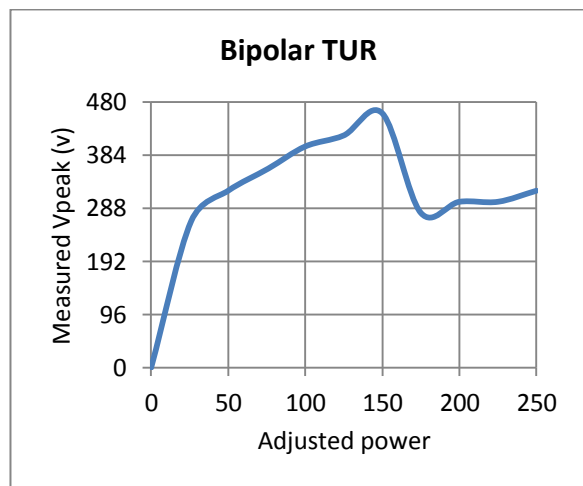
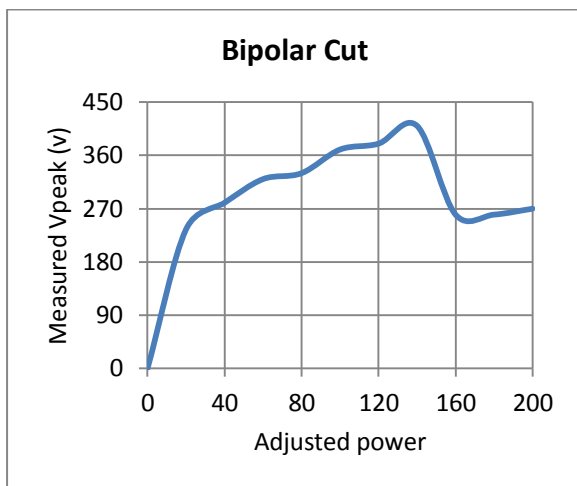
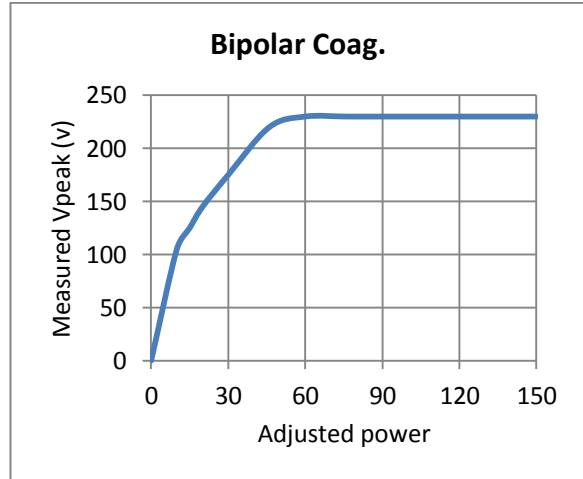
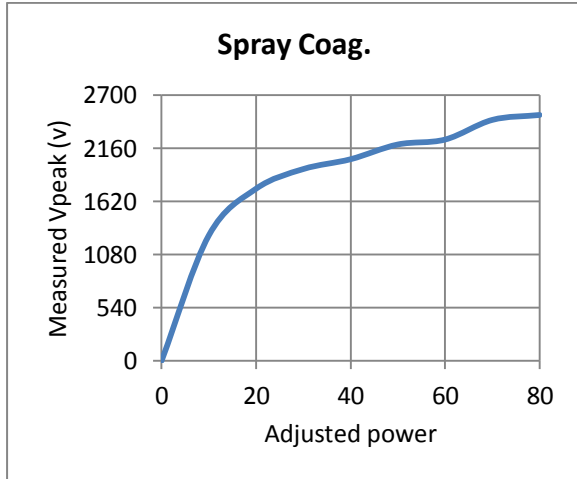

MEG1

For General Surgery

MEG1-E

For Endoscopy

MEG1-R

Radio Frequency Surgery
"MHz Technology"



KAVANDISH SYSTEM

Sales Office: Tel: (+98-21)88531318-19 Fax: (+98-21)88519063

Factory: Tel: (+98-21) 76250635-38 Fax: (+98-21) 76250637

Company: Pardis Technology Park, 20th km of Damavand Road
www.kavandish.ir info@kavandish.ir